

# MODEL : INC-2386FHFAAG

Zero Bezel with Tempered Glass  
 LED Illumination on Front, 4 Sides  
 12V Addressable LEDs, w/ IC

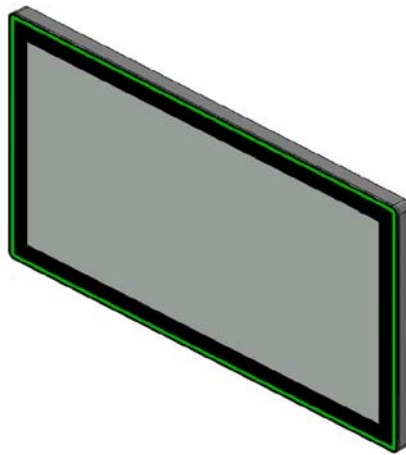

Revision	Date	History
V1.0	2025.04.11	Initial Release.

Draft \_\_\_\_\_

Date : \_\_\_\_\_

Checked: \_\_\_\_\_

Date : \_\_\_\_\_

Approved : \_\_\_\_\_

Date : \_\_\_\_\_

# Contents

## **1. General Description**

- 1.1 Overview**
- 1.2 General Specifications**
- 1.3 Environmental and Reliability Specification**
- 1.4 Power Supply Rating**
- 1.5 Input/Output Port**

## **2. User Control & OSD**

- 2.1 Key Control Board**
- 2.2 OSD Control Function**

## **3. Connector Description**

- 3.1 Summary**
- 3.2 J8: Auto Dimming/RS232 Connector**
- 3.3 J6 : 12VDC Power Input**
- 3.4 J1 : Backlight Inverter Connector**
- 3.5 J15 : OSD Board Connector**
- 3.6 J9 : 12VDC Power Input Jack**
- 3.7 J11 : DVI Input Connector**
- 3.8 J23 : VGA Input Connector**
- 3.9 J14 : LCD Interface Connector**

## **4. Standard Display Modes**

## **5. LED Backlight Driver Board Specification**

## **6. Board Dimensions**

## **7. LED Lighting Control Specification**

## **8. Packing Information**

## **9. Mechanical Structure**

# 1. General Description

## 1.1 Overview

- ◆ InnoDisplay Closed-frame LCD Monitor INC-2386FHFAAG is a high performance TFT LCD monitor providing a high quality screen image.
- ◆ This monitor supports VGA and DVI input. Other input options are available.
- ◆ Wide input resolution range up to Full HD (1920 x 1080@60Hz).
- ◆ It is designed for industrial use with Auto power on, up scaling performance adequate for low-resolution applications and enhanced design margin for reliability.
- ◆ It is available in matching touch and non-touch designs.

## 1.2 General Specifications

<b>LCD Panel</b>	<b>Size</b>	23.8" Diagonal
	<b>Active Display Area</b>	527.04(H)mm x 296.46(V)mm
	<b>Type No.</b>	AUO M238HVN01.0
	<b>Number of Pixels</b>	1920 (H) x 1080 (V)
	<b>Pixel Arrangement</b>	RGB Vertical Stripe
	<b>Pixel Pitch</b>	0.2745mm x 0.2745mm
	<b>Color Depth</b>	16.7M / 8Bit
	<b>Surface Treatments</b>	SAG 40% ,3H
	<b>Viewing Angle (CR&gt;10)</b>	R/L: 178 degree (89/89) U/D: 178 degree (89/89)
	<b>Contrast Ratio</b>	Typ. 3000 : 1
	<b>Response Time(Typ.)</b>	16ms
	<b>Average Brightness</b>	Typ. 250 cd/ m <sup>2</sup>
	<b>Frame Rate</b>	Typ. 60Hz
	<b>Backlight Unit</b>	LED
<b>Input Resolution</b>	<b>Prime</b>	1920 x 1080 @ 60 Hz
	<b>Standard</b>	640x480@60/75Hz 800x600@60/75Hz, 1024x768@60//75Hz, 1280x1024 @60/75Hz, 1280x720@60Hz 1366x768@60Hz,1600x900@60Hz, 1680x1050@60Hz,1920x1080@60Hz

Input Signal Port	VGA	15pin D-Sub x 1Port
	DVI	29pin DVI x 1 Port
	Power Jack	2.5 Ø DC Jack
Scanning Frequency	Horizontal	31 ~ 80Khz
	Vertical	55 ~75Hz
OSD Control		Menu, Select, Up, Down, Power
Plug & Play		VESA DDC 2B Ver1.3
Safety Tempered Glass		Glass 588.0mm x 367.0mm x 3.0T
LED Frame Illumination (Without Controller)		Front Type, 4 sided
		LED Type : w/ IC Type (WS2815B)
		Supports External 12V Addressable, w/IC type LED Lighting Controller
		Interface Port : Molex 43020-0600
RoHS		RoHS2 Compliance
Mounting Options		100 x 100mm M4 VESA Mounting Holes
Optional Accessories		Cables, Power Supply



**Application Caution**

- 1. Precautions for strong light exposure.**  
Strong light exposure causes degradation of polarizer and color filter.

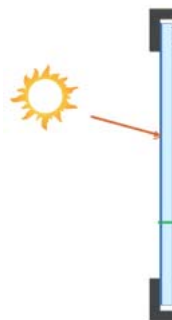

- 2. Using Conditions.**  
- Temperature inside the cabinet should be controlled 'at room temp' (0 ~ 40°C) by cooler and fan.

### 1.3 Environmental and Reliability Specification

- This specification depends on the LCD panel characteristics. Please refer to the manufacturer's panel specification for details.

Item	Symbol	Min	Max	Unit
Operating Temperature	TOP	0	+50	°C
Operating Humidity	HOP	10	90	%
Storage Temperature	TST	-20	+60	°C
Storage Humidity	HST	10	90	%

### 1.4 Power Supply Rating

Optional PSU Input Voltage	AC 100 ~ 240VAC, 50/60Hz			
Optional PSU Output Voltage	12VDC/5.0A			
Monitor DC Input Voltage	12VDC			
Power Consumption	Typ. 24W (12VDC / 2.0A)			
LED String Lighting Specification (12V Addressable, w/IC type)	Min	Typ.	Max	Unit
Input Voltage	11.4	12.0	12.6	[V]
Input Current		TBD		[A]
Power Consumption		TBD		[W]

- Conditions of Measurement
  - 1) LED pattern: LED Bar full white light, non-scrolling.
  - 2) Current consumption tolerance: + 10%.

### 1.5 Input/Output Port

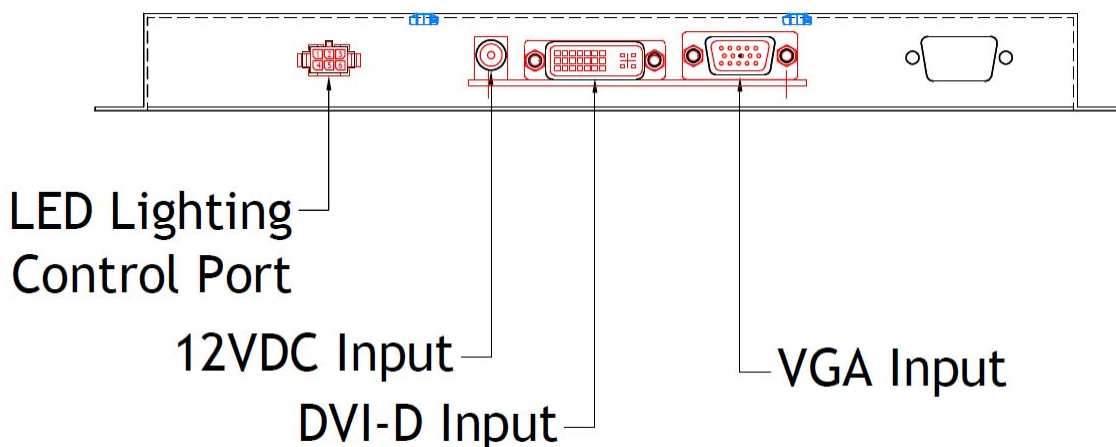

## 2. User Control & OSD

### 2.1 Key Control Board

K002

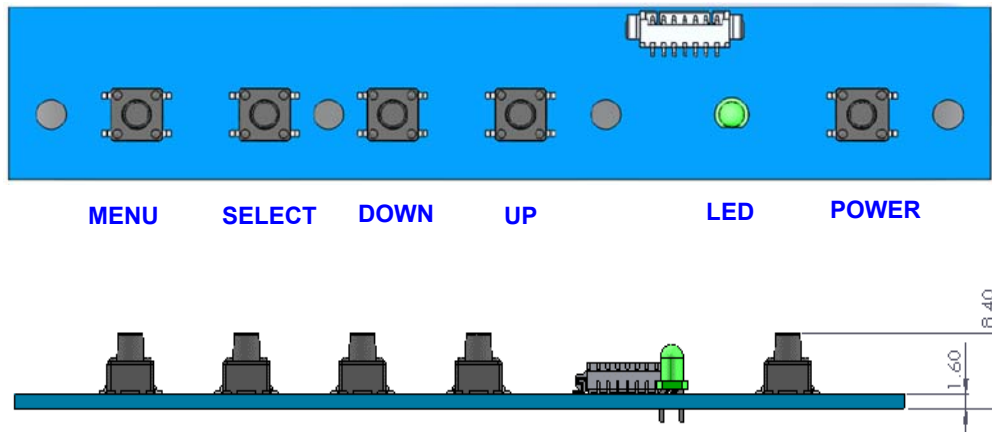

Button	Function	Status	HOT Key
LED	Indicates operation status	Green : Normal State Red : Off Mode Green Blinking : DPMS Mode	
POWER	Power on/off		
MENU	Enable MENU Window Disable MENU Window Exit from Sub function		
SELECT	Select function		No OSD Window, Input Source Change
DOWN	Move to Down or Left		No OSD Window, Auto Color
UP	Move to Up or Right		No OSD Window, Auto Configuration

## 2.2 OSD Control Function

The chosen OSD settings will be stored in memory. The OSD menu can be cleared from the screen by pressing the **MENU** button otherwise it will be automatically cleared after a few second of non-use.

### 2.2.1 OSD Main Menu

#### 1) PICTURE

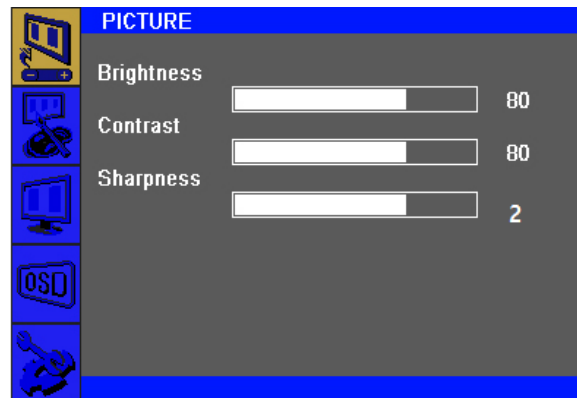

Brightness (0 ~ 100)	Increases/decreases monitor Brightness. Default: 100
Contrast (0 ~ 100)	Increases/decreases monitor Contrast. Default: 100
Sharpness (0 ~ 4)	Adjusts Sharpness of the displayed images. Default : 2

#### 2) COLOR



Color Status Management	Selects the display's color temperature. The available color settings "Normal", "Warm", "Cool", "User", "Game" mode. Default : User
Red (0 ~ 100)	Increases/decreases Red Color Temperature. Default : 50
Green (0 ~ 100)	Increases/decreases Green Color Temperature. Default : 50
Blue (0 ~ 100)	Increases/decreases Blue Color Temperature. Default : 50
Auto Color	Automatically adjusts the system color to the input VGA.

### 3) SCREEN (VGA input only)

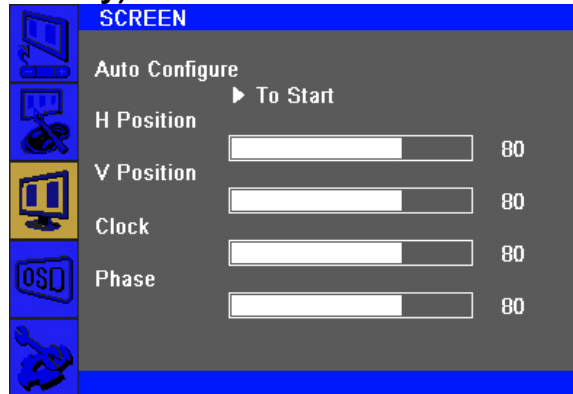

Auto Configure	Automatically adjusts the system clock to the input VGA.
H Position (0 ~ 100)	Moves the image horizontally on the display in single-pixel increments. Default : 50
V Position (0 ~ 100)	Moves the image vertically on the display in single-pixel increments. Default : 50
Clock (0 ~ 100)	Allows fine adjustments of the panel's pixel dot clock. Default : 50
Phase (0 ~ 100)	Allows fine adjustments of the panel's pixel dot clock phase. Default : 50
WXGA Mode	Selects WXGA Mode Off, 1024 x 768, 1280 x 768, 1360 x 768, 1366 x 768 Default : Off

### 4) OSD

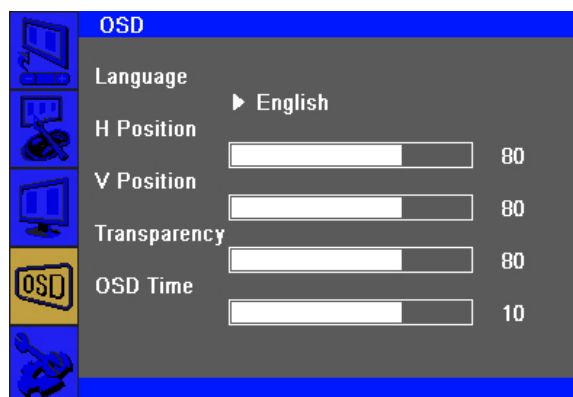

Language	Selects the OSD's display language. The available languages are English, Deutsch, Français, Italiano, Español, Korean. Default : English
H Position (0 ~ 100)	Adjusts the horizontal location of the OSD menus on the display. Default : 50

V Position (0 ~ 100)	Adjusts the vertical location of the OSD menus on the display. Default : 50
Transparency (0 ~ 100)	Adjusts the transparency of the OSD menus on the display. Default : 33
OSD Time (0 ~ 60)	Adjusts how long the touch monitor will wait without OSD button activity before closing the OSD. The adjustable range is between 0 and 60 seconds. Default : 10

### 5) SETUP



Source	Selects Input Source VGA (RGB), DVI.
Factory reset	Restores all factory default settings for OSD-adjustable parameters and for Preset Video Mode timings.
Aspect	Switches the scaling method between Full Scaling and Maintain Aspect Ratio. Default : Off

### 3. Connector Description

#### 3.1 Summary

Reference	Item	Description	Type	Manufacture
J8	Connector	Auto-Dimming/RS232 Connector	SMW200-05	YEONHO
J6	Connector	External 12VDC Power Input Connector	20010WS-04	YEONHO
J1	Connector	Backlight Inverter Connector	SMAW200-8	YEONHO
J15	Connector	OSD Board Connector	SMAW200-07	YEONHO
J9	Connector	12VDC Power Input Jack (2.5Pai)	DC005	-
J11	Connector	DVI-D Input(TMDS) Connector	DVI-D 24P	-
J23	Connector	VGA Input Connector	15P D-SUB	-
J14	Connector	LCD Interface Connector(2Ch LVDS)	YDW200-30	YEONHO

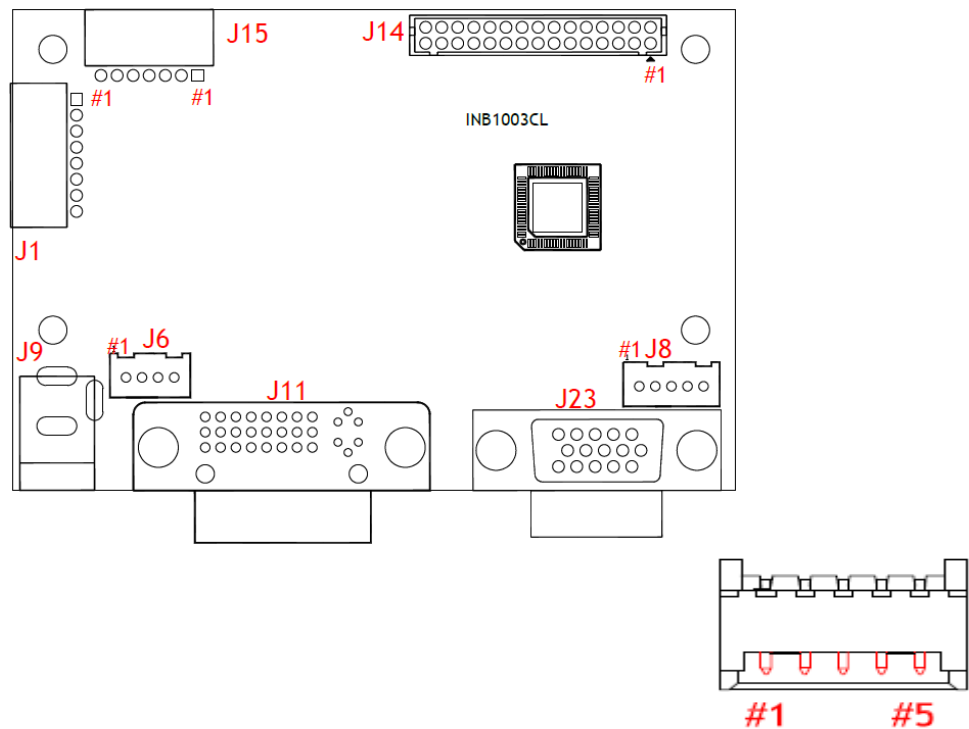

#### 3.2 J8: Auto-Dimming / RS232 Connector

Pin No.	Symbol	Description
1	5VDC	VCC 5V
2	RS232 TX	RS232 TX
3	RS232 RX	RS232 RX
4	Auto- Backlight	Auto-Dimming
5	GND	Ground

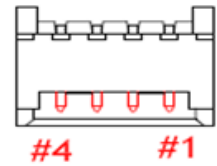
**3.3 J6: 12VDC Power Input Connector**

Pin No.	Symbol	Description
1	VCC	12VDC
2	VCC	12VDC
3	GND	Ground
4	GND	Ground

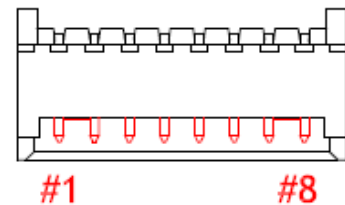
**3.4 J1: Backlight Inverter Connector**

Pin No.	Symbol	Description
1	DIM-ADJ	DIM-adjustment analog dimming control signal. * make sure inverter specification
2	ON/OFF	Inverter digital ON(3.3V)/OFF(0V) signal.
3,4,5,	GND	Ground
6,7,8	VCC	12VDC

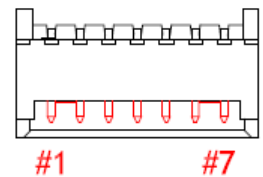
**3.5 J15: OSD Board Connector**

Pin No.	Symbol	Description
1	VCC	+5V Power for IR sensor
2	IRQ	Infrared rays signal line.
3	LED1	Green LED
4	LED2	Red LED
5	GND	Ground
6	ADC-IN0	Menu, Up
7	ADC-IN1	Power, Down, Up

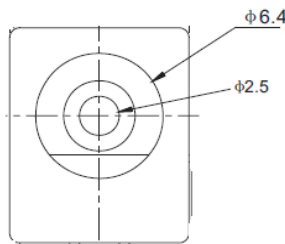
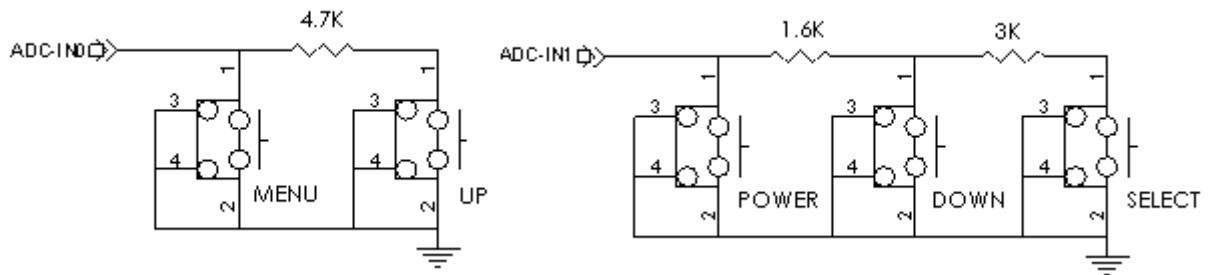

**3.6 J9: 12VDC Power Input Jack**

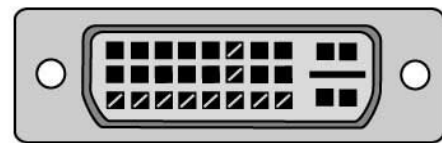
Pin No.	Symbol	Description
-	GND	Ground
+	VCC	12VDC

**3.7 J11: DVI-D Input (TMDS) Connector**

Pin No.	Symbol	Description
1	TMDS DATA2-	TMDS DATA2 Differential Negative Signal
2	TMDS DATA2+	TMDS DATA2 Differential Positive Signal
3	TMDS DATA2 Shield	Shield for TMDS Channel #2
4	NC	No Connection
5	NC	No Connection
6	DDC Clock	The Data Line for the DDC Interface
7	DDC Data	The Clock Line for the DDC Interface
8	NC	No Connection
9	TMDS DATA1-	TMDS DATA1 Differential Negative Signal
10	TMDS DATA1+	TMDS DATA1 Differential Positive Signal
11	TMDS DATA1 Shield	Shield for TMDS Channel #1
12	NC	No Connection
13	NC	No Connection
14	+5V Power	+5 Volt signal for EDID (Un-powered Monitor)
15	GND(for +5V)	Ground for +5 Volt Power pin, Sync return

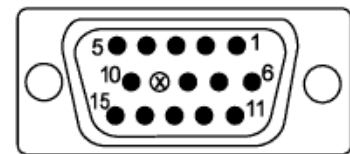
16	HPD	Identify the Presence of a Monitor
17	TMDS DATA0-	TMDS DATA0 Differential Negative Signal
18	TMDS DATA0+	TMDS DATA0 Differential Positive Signal
19	TMDS DATA0 Shield	Shield for TMDS Channel #0
20	NC	No Connection
21	NC	No Connection
22	TMDS CLOCK Shield	Shield for TMDS Clock Differential Pair
23	TMDS CLOCK+	TMDS DATA0 Differential Positive Signal
24	TMDS CLOCK-	TMDS DATA0 Differential Negative Signal



### 3.8 J23: VGA Input Connector

Pin No.	Symbol	Description
1	Red1	Red Analog Input
2	Green1	Green Analog Input
3	Blue1	Blue Analog Input
4	GND	Ground
5	GND	Ground
6	GND	Ground
7	GND	Ground
8	GND	Ground
9	NC	No Connection
10	GND	Ground
11	GND	Ground
12	DSDA	DDC-SDA
13	HSYNC	Horizontal Sync
14	VSNC	Vertical Sync
15	DSCL	Serial Clock Input

**3.9 J14: LCD Interface Connector (8bit 2Ch LVDS)**

Pin No.	Symbol	Description
1	MOD_PWR	Panel Power (12V, 5V or 3.3V)
2	MOD_PWR	Panel Power (12V, 5V or 3.3V)
3	Option	High/Low for LCD Option
4	MOD_PWR	Panel Power (12V, 5V or 3.3V)
5	NC	No Connection
6	NC	No Connection
7	GND	Ground
8	GND	Ground
9	Y3N-EVEN	Negative(-) LVDS differential second 3 data
10	Y3P-EVEN	Positive(+) LVDS differential second 3 data
11	YCN-EVEN	Negative(-) LVDS differential second Clock
12	YCP-EVEN	Positive(+) LVDS differential second Clock
13	Y2N-EVEN	Negative(-) LVDS differential second 2 data
14	Y2P-EVEN	Positive(+) LVDS differential second 2 data
15	Y1N-EVEN	Negative(-) LVDS differential second 1 data
16	Y1P-EVEN	Positive(+) LVDS differential second 1 data
17	Y0N-EVEN	Negative(-) LVDS differential second 0 data
18	Y0P-EVEN	Positive(+) LVDS differential second 0 data
19	GND	Ground
20	GND	Ground
21	Y3N- ODD	Negative(-) LVDS differential first 3 data
22	Y3P-ODD	Positive(+) LVDS differential first 3 data
23	YCN- ODD	Negative(-) LVDS differential first Clock
24	YCP- ODD	Positive(+) LVDS differential first Clock
25	Y2N- ODD	Negative(-) LVDS differential first 2 data
26	Y2P- ODD	Positive(+) LVDS differential first 2 data
27	Y1N- ODD	Negative(-) LVDS differential first 1 data
28	Y1P- ODD	Positive(+) LVDS differential first 1 data
29	Y0N- ODD	Negative(-) LVDS differential first 0 data
30	Y0P- ODD	Positive(+) LVDS differential first 0 data

## 4. Standard Display Modes

ITEM	STD	Resolution	Pixel Frequency (MHz)	Vertical Frequency (Hz)	Horizontal Frequency (KHz)	Sync. Polarity (H/V)	Remark
1		<b>640*400</b>	<b>25.175</b>	<b>59.940</b>	<b>31.469</b>		
2		<b>640*480</b>	<b>25.175</b>	<b>59.940</b>	<b>31.469</b>		<b>VGA</b>
3	VESA	<b>640*480</b>	<b>25.200</b>	<b>60.000</b>	<b>31.500</b>		<b>VGA</b>
4	VESA	<b>640*480</b>	<b>31.500</b>	<b>72.809</b>	<b>37.861</b>		<b>VGA</b>
5	VESA	<b>640*480</b>	<b>31.500</b>	<b>75.000</b>	<b>37.500</b>		<b>VGA</b>
6	VESA	<b>800*600</b>	<b>40.000</b>	<b>60.317</b>	<b>37.879</b>		<b>SVGA</b>
7	VESA	<b>800*600</b>	<b>50.000</b>	<b>72.188</b>	<b>48.077</b>		<b>SVGA</b>
8	VESA	<b>800*600</b>	<b>49.500</b>	<b>75.000</b>	<b>46.875</b>		<b>SVGA</b>
9	VESA	<b>1024*768</b>	<b>65.000</b>	<b>60.000</b>	<b>48.363</b>		<b>XGA</b>
10	VESA	<b>1024*768</b>	<b>75.000</b>	<b>70.069</b>	<b>56.476</b>		<b>XGA</b>
11	VESA	<b>1024*768</b>	<b>78.750</b>	<b>75.029</b>	<b>60.023</b>		<b>XGA</b>
12		<b>1152*864</b>	<b>94.500</b>	<b>60.000</b>	<b>63.851</b>		
13	VESA	<b>1152*864</b>	<b>108.000</b>	<b>75.000</b>	<b>67.500</b>		
14		<b>1280*720</b>	<b>74.501</b>	<b>59.856</b>	<b>44.772</b>		<b>WXGA</b>
15		<b>1366*768</b>	<b>72.000</b>	<b>59.960</b>	<b>47.368</b>		<b>WXGA</b>
16	VESA	<b>1280*1024</b>	<b>108.000</b>	<b>60.020</b>	<b>63.981</b>		<b>SXGA</b>
17	VESA	<b>1280*1024</b>	<b>135.000</b>	<b>75.025</b>	<b>79.976</b>		
18		<b>1680*1050</b>	<b>146.250</b>	<b>59.954</b>	<b>65.290</b>		<b>WSXGA+</b>
19		<b>1600* 900</b>	<b>118.998</b>	<b>55.920</b>	<b>60.000</b>		
20		<b>1920*1080</b>	<b>138.500</b>	<b>59.934</b>	<b>66.587</b>		
21		<b>1920*1080</b>	<b>148.500</b>	<b>60.000</b>	<b>67.500</b>		<b>1080P</b>
22		<b>1920*1080</b>	<b>148.352</b>	<b>59.940</b>	<b>67.433</b>		<b>1080P</b>

## 5. LED Backlight Driver Board Specification

### 5.1 Electrical Specification

Item	Symbol	Spec	Unit	Remarks
Input Voltage 1	Vin	11.4 ~13.8	V	
Input Voltage 2	ON / OFF	2.4 ~ 5.25	V	
Operating Temperature	TOP	0 ~ 50	℃	
Storage Temperature	Tstg	-20 ~60	℃	
Relative Humidity	RH	90	%	

### 5.2 Control Signal

Item	Symbol	Status	Action	Remarks
J2 #8	ON/OFF	HIGH	LAMP-ON	2.4 ~ 5.25V
		LOW	LAMP-OFF	0.8V Max

### 5.3 Output Characteristics

NO	Item	Symbol	Condition	Min.	Typ.	Max	Unit
1	Input Voltage	Vin	'-	11.4	12.0	13.8	V
2	Input Current	Iin	Vin=12V Dim=0V	-	-	3.0	A
3	Output Voltage	Vout	Vin=12V Dim=0V	38.87	44.86	47.85	Vdc
4	Output Current	Iout	Vin=12V Dim=0V	-	55	60	mA
5	Backlight On/Off Control	ON	'-	2.4		5.25	V
		OFF	'-	-0.3		0.8	V

### 5.4 Interface

#### 5.4.1 J2 Connector : SMW200-09(YeonHo) or EQ

Pin No	Symbol	Remark
1,2,3	VIN	Voltage Input 12.0V
4	NC	No Connection
5,6,7	GND	Ground
8	ON/OFF	LED Driver ON/OFF Signal
9	DIM	Diming Control

#### 5.4.2 J1 Connector : SMW200-08P(YeonHo) or EQ

Pin No	Symbol	Remark
1,2,3,4	VLED	LED Output Voltage
5,6,7,8	RTN1,2,3,4	Feedback1,2,3,4 (Return 1,2,3,4)



6.3 LED Driver Board (AVK-1010) Dimension (50mm x 50mm x 10mm)

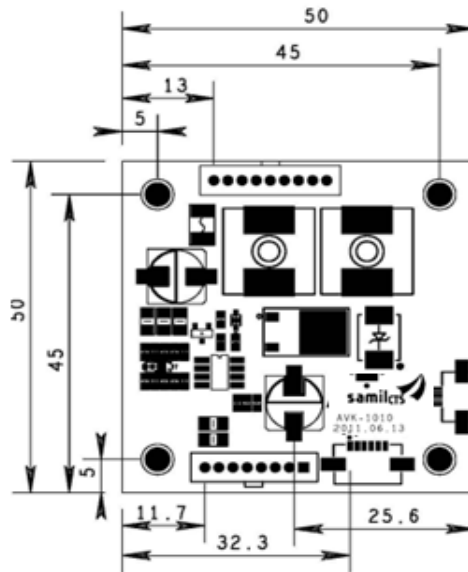

## 7. LED Lighting Control Interface Specification

### 7.1 Connector Spec

- Connector: Molex 43020-0600





- Matching Housing: Molex 43025-0600

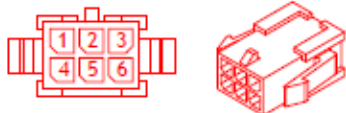

### 7.2 External LED Connector Pin Map

#### 7.2.1 With IC (Dual-Line) LED Bar Board

PCB Type LED Port Composition (21.5" ~ 27.0" w/IC 6Pin , 12V/ADDR)			
Pin No	Monitor Description	Female Connector (Molex 43020-0600)	Male Connector (Molex 43025-0600)
P1	VCC 12V		
P2	CTL (Control Line)		
P3	GND		
P4	NC		
P5	NC		
P6	NC		

Pin No	Symbol	Remark
1	12V	DC 12V
2	CTL	With IC LED Control Line
3	GND	GND
4,5,6	NC	Non Connection

### 7.3 LED (WS2815B) Spec

#### 7.3.1 LED (WS2815B) Pin Configuration

##### PIN Configuration

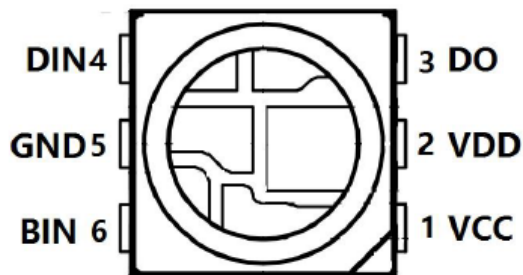

##### PIN Function

NO.	Symbol	PIN	Function description
1	VCC	VCC	IC POWER SUPPLY, Suspended or connected with a filter capacitor to GROUND
2	VDD	VDD	LED POWER SUPPLY, connect to "+12V"
3	DO	DO	Control data signal output
4	DIN	DIN	Control data signal input
5	GND	GND	Data & Power Grounding
6	BIN	BIN	Backup Control data signal input

#### 7.3., LED (WS2815B) Circuit

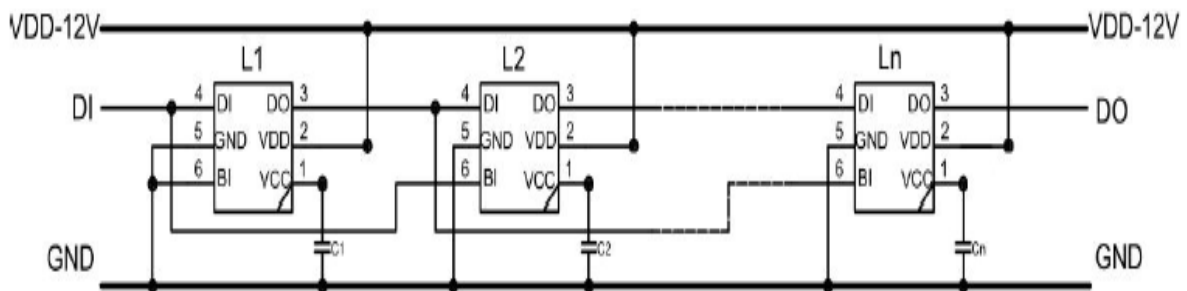

## 8. Packing Information

Item	Q'ty	Dimension (W x H x D)	Weight(Kg)	Remark
Closed Frame	1Pcs	588.0mm x 367.0mm x 51.0mm	TBD	
Box Packing			TBD	
Pallet Size			TBD	
Pallet Packing			TBD	

## 9. Mechanical structure

ASSEMBLY ITEM NUMBER	PART CHARACTERISTICS		MATERIAL
	NUMBER OF POSITION	PANEL MOUNT OPTION	
	43020-0200	02	
43020-0201	02	NO	
43020-0400	04	YES	
43020-0401	04	NO	
43020-0600	06	YES	
43020-0601	06	NO	
43020-0800	08	YES	
43020-0801	08	NO	
43020-1000	10	YES	
43020-1001	10	NO	
43020-1200	12	YES	
43020-1201	12	NO	
43020-1400	14	YES	
43020-1401	14	NO	
43020-1600	16	YES	
43020-1601	16	NO	
43020-1800	18	YES	
43020-1801	18	NO	
43020-2000	20	YES	
43020-2001	20	NO	
43020-2200	22	YES	
43020-2201	22	NO	
43020-2400	24	YES	
43020-2401	24	NO	

CKT. NO.	DIM. 'A'	DIM. 'B'	DIM. 'C'	DIM. 'D'
2	.152/(3.86)	N/A	.166/(4.21)	.311/(7.90)
4	.270/(6.85)	.118/(3.00)	.284/(7.21)	.429/(10.90)
6	.388/(9.85)	.236/(6.00)	.402/(10.21)	.547/(13.89)
8	.506/(12.85)	.354/(9.00)	.520/(13.21)	.665/(16.89)
10	.624/(15.85)	.472/(12.00)	.638/(16.21)	.783/(19.89)
12	.742/(18.85)	.591/(15.00)	.756/(19.21)	.901/(22.89)
14	.860/(21.85)	.709/(18.00)	.874/(22.20)	1.019/(25.88)
16	.978/(24.85)	.827/(21.00)	.992/(25.20)	1.137/(28.88)
18	1.096/(27.85)	.945/(24.00)	1.110/(28.20)	1.255/(31.88)
20	1.215/(30.85)	1.063/(27.00)	1.229/(31.22)	1.373/(34.87)
22	1.333/(33.85)	1.181/(30.00)	1.347/(34.22)	1.491/(37.87)
24	1.451/(36.85)	1.299/(33.00)	1.465/(37.22)	1.609/(40.87)

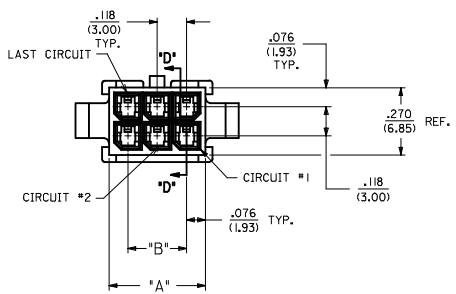

- NOTES:
- HOUSING MATERIAL:
  - 'A' - UNFILLED POLYESTER, RATED U.L. 94V-0, COLOR IS BLACK.
  - 'B' - UNFILLED NYLON, RATED U.L. 94V-0, HALOGEN-FREE, COLOR IS BLACK.
  - FINISH: N/A
  - PRODUCT SPECIFICATION: PS-43045
  - PACKAGING SPECIFICATION: PK-43020-001
  - THIS HOUSING MATES WITH MICRO-FIT RECEPTACLE #43025-\*\*\*\*
  - THIS HOUSING TO BE USED WITH MOLEX MALE TERMINAL #43031-\*\*\*\*
  - DESIGNED FOR .055(1.4) MINIMUM TO A .100(2.54) MAXIMUM THICK PANEL OR PRINTED CIRCUIT BOARD.
  - SEE SECTION 'D'-D' FOR TERMINAL ORIENTATION IN HOUSING.
  - PANEL MOUNT FEATURES MUST LOCK ON SIDE OPPOSITE PUNCH SIDE FOR OPTIMUM RETENTION.
  - PART CONFORMS TO CLASS 'B' REQUIREMENTS OF COSMETIC SPECIFICATION PS-45499-002. SOME HOUSINGS MAY HAVE A SMALL GATE BLEMISH NEAR THE GATE LOCATION THAT DOES NOT AFFECT FUNCTIONALITY.

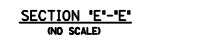
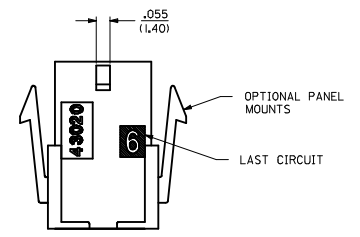
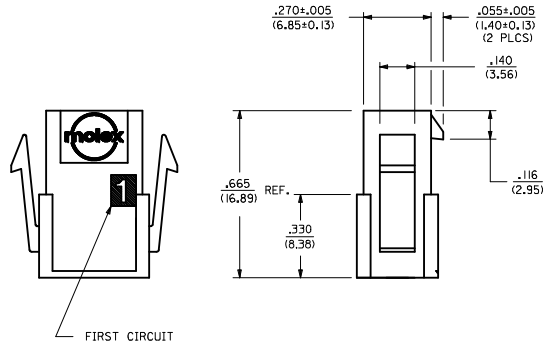
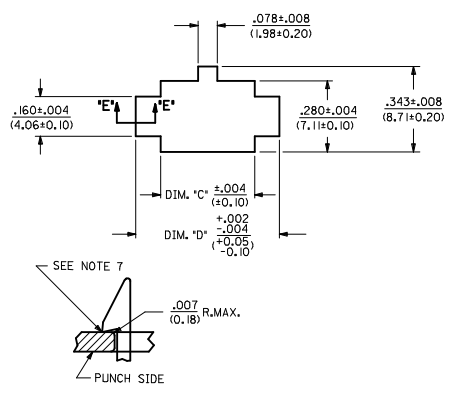

SECTION 'E'-E'  
NO SCALE

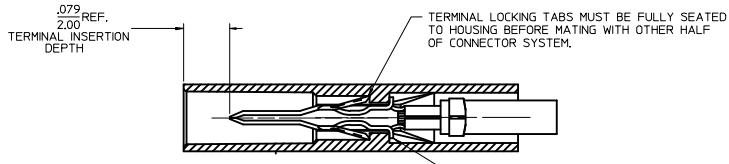

SECTION 'B'-B'

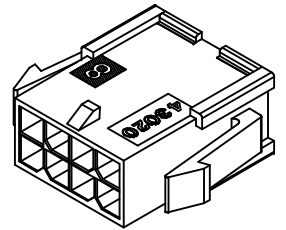

PLUG WITH OPTIONAL  
PANEL MOUNTS  
ISO VIEW  
(8 CIRCUIT SHOWN)

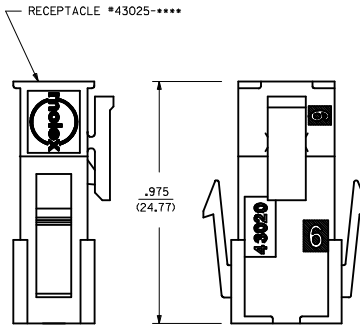

MATED MICRO-FIT CONNECTOR

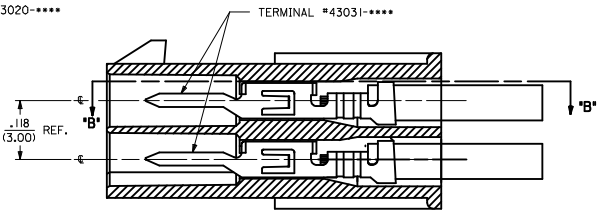

SECTION 'D'-D'  
WITH TERMINAL  
SCALE 8X

UPDATE PUNCHED HOLE IEC NO. UCF2017-0525 DRAWN/OUTLES 2016/09/13 CHKD/SSOUSEK 2016/09/13 APPR/FSM TH 2016/10/07	QUALITY SYMBOLS	GENERAL TOLERANCES (UNLESS SPECIFIED)	DIMENSION STYLE	SCALE	DESIGN UNITS	THIRD ANGLE PROJECTION
	▽=0	mm INCH	IN/MM	METRIC		
	▽=0	4 PLACES ± --- ± ---	DRAWN BY DATE			
	▽=0	3 PLACES ± --- ± .010	AFG 1993/01/07			
	2 PLACES ± 0.25 ± .014	CHECKED BY DATE				
	1 PLACE ± 0.35 ± ---	BAP 1993/01/07				
	0 PLACE ± --- ± ---	APPROVED BY DATE				
		FSM TH 2016/10/07				
		ANGULAR ±1/2°	MATERIAL NO.	DOCUMENT NO.		
		DRAFT WHERE APPLICABLE MUST REMAIN WITHIN DIMENSIONS	SEE CHART	SDA-43020-****		
			SIZE D			
			THIS DRAWING CONTAINS INFORMATION THAT IS PROPRIETARY TO MOLEX INCORPORATED AND SHOULD NOT BE USED WITHOUT WRITTEN PERMISSION			

PART CHARACTERISTICS		
NUMBER OF POSITION	ASSEMBLY ITEM NUMBER	MATERIAL
02	43025-0200	'B'
04	43025-0400	
06	43025-0600	
08	43025-0800	
10	43025-1000	'A'
12	43025-1200	
14	43025-1400	'B'
16	43025-1600	'A'
18	43025-1800	'B'
20	43025-2000	
22	43025-2200	'A'
24	43025-2400	

CKT. NO.	DIM. "A" +0.14 -0.10 +0.35 -0.25	DIM. "B"
2	.152/(3.86)	N/A
4	.270/(6.85)	.118/(3.00)
6	.388/(9.85)	.236/(6.00)
8	.506/(12.85)	.354/(9.00)
10	.624/(15.85)	.472/(12.00)
12	.742/(18.85)	.591/(15.00)
14	.860/(21.85)	.709/(18.00)
16	.978/(24.85)	.827/(21.00)
18	1.096/(27.85)	.945/(24.00)
20	1.215/(30.85)	1.063/(27.00)
22	1.333/(33.85)	1.181/(30.00)
24	1.451/(36.85)	1.299/(33.00)

- NOTES:**
- HOUSING MATERIAL:  
'A' - UNFILLED POLYESTER, RATED UL, 94V-0, COLOR IS BLACK.  
'B' - UNFILLED NYLON, RATED UL, 94V-0, HALOGEN-FREE, COLOR IS BLACK.
  - FINISH: N/A
  - PRODUCT SPECIFICATION: PS-43045
  - PACKAGING SPECIFICATION: PK-43025-001
  - THIS RECEPTACLE MATES WITH 43020, 43045.
  - THIS RECEPTACLE TO BE USED WITH MOLEX FEMALE TERMINAL SERIES 43030 OR 46235. SEE SECTION 'A'-A' FOR TERMINAL ORIENTATION IN HOUSING.
  - FOR OVERMOLDING PARAMETERS SEE ENGINEERING SPECIFICATION #SDS-43025-1000.
  - TOP PULL TABS ARE NOT AVAILABLE ON 2 AND 4 CIRCUIT PARTS.
  - MOLEX RECOMMENDS THE USE OF MICRO-FIT TEST PLUG, SERIES NO. 44242-\*\*\*\*\* WHENEVER TESTING IS PERFORMED. TEST PLUGS MUST NOT BE USED FOR MAKE OR BREAK UNDER LOAD. MOLEX DOES NOT RECOMMEND USING STANDARD MATING COMPONENTS FOR HARNESS TESTING PURPOSES.
  - SOME HOUSINGS MAY HAVE A SMALL GATE BLEMISH NEAR THE GATE THAT DOES NOT AFFECT FUNCTIONALITY.
  - HOUSINGS HAVE EITHER AN IDENTIFIER RIB OR ENGRAVED '1' SYMBOL TO INDICATE CIRCUIT #1. IDENTIFIER TYPE IS TOOL DEPENDENT AND NOT SELECTABLE.
  - DIMENSION 'A' MEASURED AT DATUM  $\square$ -A
  - THIS PART CONFORMS TO CLASS 'B' REQUIREMENTS OF COSMETIC SPECIFICATION PS-45499-002.

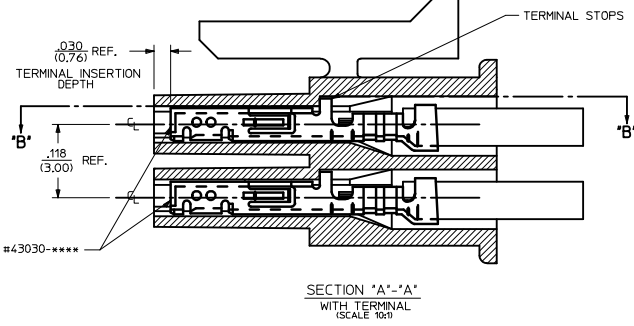
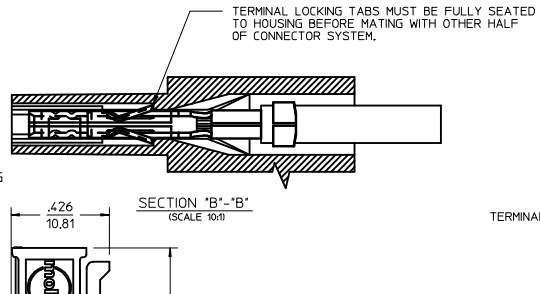
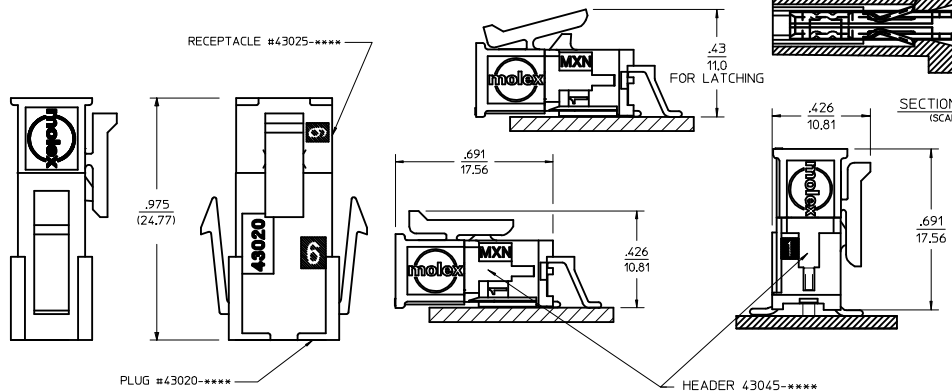
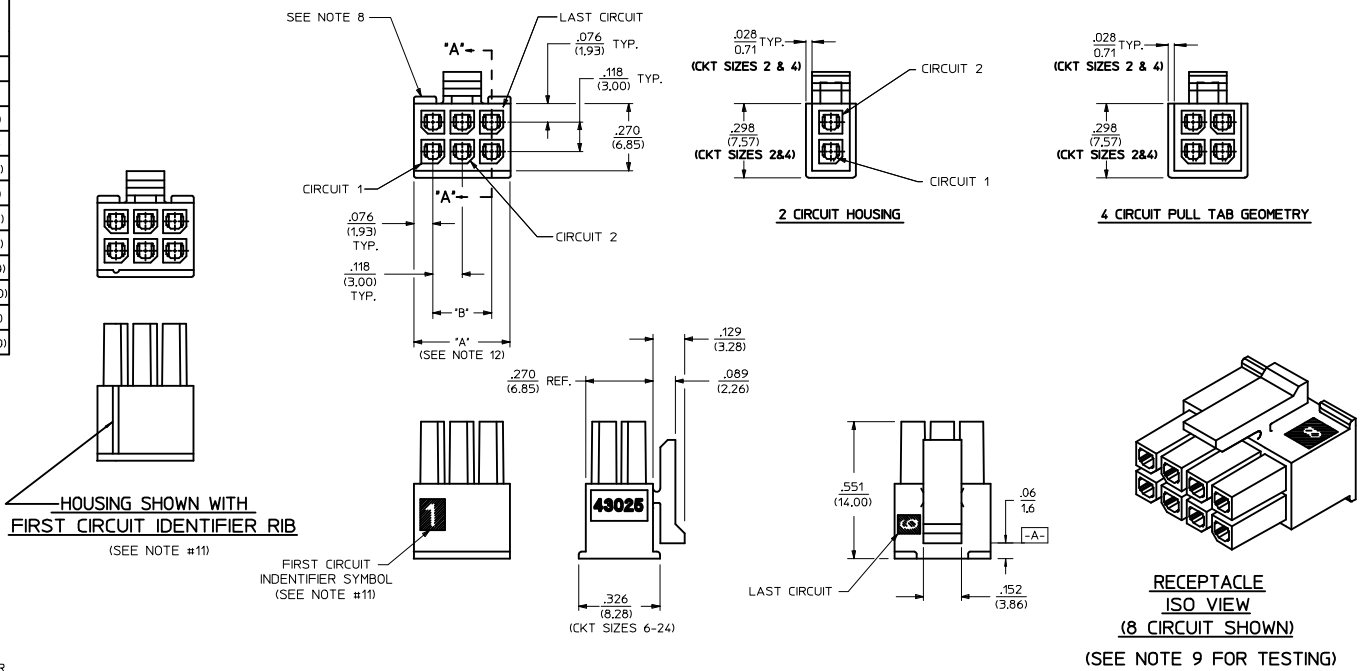

MATED MICRO-FIT CONNECTOR

<b>ADD MATED VIEW</b> IEC NO: UCP2016-4677 DRAWN BY: DRYNWAPELDOORN CHECKED BY: CHYKJDOFX APPROVED BY: APPREHSMITH DATE: 2016/06/03 DATE: 2016/06/03 DATE: 2016/06/09	QUALITY SYMBOLS ▽=0 ▽=0 ▽=0	GENERAL TOLERANCES (UNLESS SPECIFIED): <table border="1"> <tr> <th></th> <th>mm</th> <th>INCH</th> </tr> <tr> <td>4 PLACES</td> <td>±.010</td> <td>±.010</td> </tr> <tr> <td>3 PLACES</td> <td>±.014</td> <td>±.014</td> </tr> <tr> <td>2 PLACES</td> <td>±.025</td> <td>±.010</td> </tr> <tr> <td>1 PLACE</td> <td>±.035</td> <td>±.010</td> </tr> <tr> <td>0 PLACE</td> <td>±.050</td> <td>±.010</td> </tr> </table>		mm	INCH	4 PLACES	±.010	±.010	3 PLACES	±.014	±.014	2 PLACES	±.025	±.010	1 PLACE	±.035	±.010	0 PLACE	±.050	±.010	DIMENSION STYLE IN/MM SCALE DESIGN UNITS METRIC	DATE 1993/01/14 DATE 1993/01/14 DATE 2016/05/02	TITLE MICRO-FIT (3.0) 2 THRU 24 CIRCUIT RECEPTACLE <b>molex</b>	MATERIAL NO. <b>SEE CHART</b>	DOCUMENT NO. SDA-43025-****	SHEET NO. 1 OF 1
		mm	INCH																							
	4 PLACES	±.010	±.010																							
	3 PLACES	±.014	±.014																							
2 PLACES	±.025	±.010																								
1 PLACE	±.035	±.010																								
0 PLACE	±.050	±.010																								
DRAFT WHERE APPLICABLE MUST REMAIN WITHIN DIMENSIONS		ANGULAR ±1/2°		THIS DRAWING CONTAINS INFORMATION THAT IS PROPRIETARY TO MOLEX INCORPORATED AND SHOULD NOT BE USED WITHOUT WRITTEN PERMISSION		SIZE D																				