

Cam locks Series 400-500 Model 503 RS1

Characteristics:

- mechanical re-programmable lock
- made in brass
- external finish in nickel
- rotation 90° clockwise
- resistant to opening with method "bumping"
- resistant to opening with picks - "picking"
- resistant to drilling

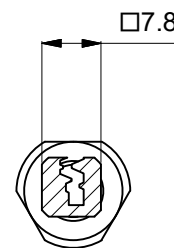
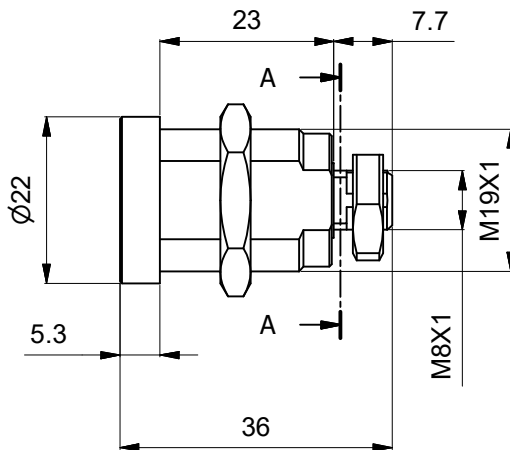
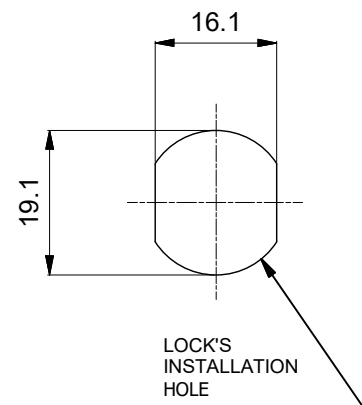
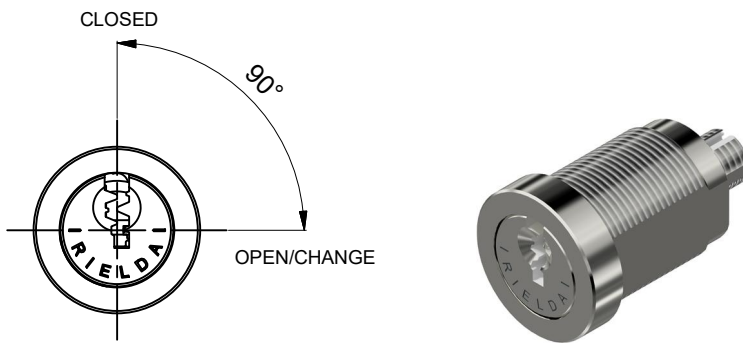

A-A