

# MODEL : INC-4306UHEFAPC-U

Zero Bezel with PCAP Touchscreen  
 LED Illumination on Edge and Front, 4 Sides  
 12V Addressable LEDs, w/ IC



Revision	Date	History
V0.1	2024.10.21	Initial Release.
V1.0	2024.10.31	Added Touch Screen Model Name P1-430C-14846A-1B

Draft \_\_\_\_\_

Date : \_\_\_\_\_

Checked: \_\_\_\_\_

Date : \_\_\_\_\_

Approved : \_\_\_\_\_

Date : \_\_\_\_\_

---

# Contents

## 1. General Description

- 1.1 Overview
- 1.2 General Specifications
- 1.3 Environmental and Reliability Specification
- 1.4 Power Supply Rating
- 1.5 Input/Output Port

## 2. User Control & OSD

- 2.1 Key Control Board
- 2.2 OSD Control Function

## 3. Connector Description

- 3.1 Overview
- 3.2. J1: DC 24V Power Input Jack
- 3.3. J2: DC 12V Power Input Jack(Optional)
- 3.4. J3: 12V/24V SMPS Power Input Connector
- 3.5. J4: Backlight inverter Connector
- 3.6. J5: DC Power Output Connector
- 3.7. CNF1: V by One Output Connector
- 3.8. J6: eDP Output Connector
- 3.9. J7: Auto Diming/RS232 Connector
- 3.10. J8: OSD Board Connector
- 3.11. HDMI1: HDMI Input Connector
- 3.12. DP1: DP (Display Port) Input Connector

## 4. Standard Display Modes

## 5. LED Backlight Driver Board Specification

## 6. Board Dimensions

## 7. LED Lighting Control Specification

## 8. Touchscreen Specification

## 9. Packing Information

## 10. Mechanical Structure

# 1. General Description

## 1.1 Overview

- ◆ INNODISPLAY Closed-frame LCD Monitor INC-4306UHEFAPC-U is a high performance TFT LCD monitor providing a high quality screen image.
- ◆ This monitor supports HDMI and DP input. Other input options are available.
- ◆ Wide input resolution range up to UHD (3840 x 2160@60Hz).
- ◆ It is designed for industrial use with Auto power on, up scaling performance adequate for low-resolution applications and enhanced design margin for reliability.
- ◆ It is available in matching touch and non-touch designs.

## 1.2 General Specifications

<b>LCD Panel</b>	<b>Size</b>	42.5" Diagonal
	<b>Active Display Area</b>	941.184mm(H) x 529.416mm(V)
	<b>Type No.</b>	BOE DV430QUM-N10
	<b>Number of Pixels</b>	3840 (H) x 2160 (V)
	<b>Pixel Arrangement</b>	RGB Vertical Stripe
	<b>Pixel Pitch</b>	0.2451mm x 0.2451mm
	<b>Color Depth</b>	1.07B True Colors
	<b>Surface Treatments</b>	Anti-Glare Haze 1%, Hard –coating (3H)
	<b>Viewing Angle (CR&gt;10)</b>	R/L: 178 degree (89/89) U/D: 178 degree (89/89)
	<b>Contrast Ratio</b>	Typ. 1200 : 1
	<b>Response Time(Typ.)</b>	8ms
	<b>Average Brightness</b>	Typ. 500 cd/ m <sup>2</sup>
	<b>Frame Rate</b>	Typ. 60Hz
	<b>Backlight Unit</b>	LED
<b>Input Resolution</b>	<b>Prime</b>	3840 x 2160@60Hz
	<b>Standard</b>	800x600@60/75Hz, 1024x768@60/75Hz, 1280x1024@60/75Hz,1600x900@60Hz, 1680x1050@60Hz,1920x1080@60Hz, 1920x1200@60Hz, 2560x 1600@60Hz, 3840x2160@30Hz , 3840x2160@60Hz

<b>Input Signal Port</b>	HDMI 2.0	19pin HDMI Jack x 1 Port
	DP(Display Port) 1.2	20pin DP Jack x 1 Port
	Power Jack	Power Mini-Din 4P x 1 Port
<b>Scanning Frequency</b>	Horizontal	30 ~130Khz
	Vertical	55 ~75Hz
<b>OSD Control</b>		Menu, Select, Up, Down, Power
<b>Plug &amp; Play</b>		VESA DDC 2B Ver1.3
<b>Touchscreen</b>	Touch Panel	P-CAP Touch : 43.0" Edge-Slim Touch / 10 Point (P1-430C-14816A-1B)
	Controller	STC-A
	Controller Interface	USB 2.0 Type "B"
<b>LED Frame Illumination (Without Controller)</b>		Edge / Front Type, 4 sided
		LED Type : w/ IC Type (WS2815B-V3)
		Supports External 12V Addressable, w/IC type LED Lighting Controller
		Interface Port : Molex 43020-0600
<b>RoHS</b>		RoHS2 Compliance
<b>Mounting Options</b>		400(H) x 400(V)mm M6 VESA Mounting Holes
<b>Optional Accessories</b>		Cables, Power Supply

**Application Caution**

- Precautions for strong light exposure.**  
Strong light exposure causes degradation of polarizer and color filter.

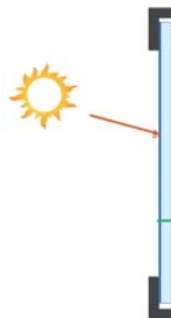

- Using Conditions.**

- Temperature inside the cabinet should be controlled 'at room temp' (0 ~ 40°C) by cooler and fan.

### 1.3 Environmental and Reliability Specification

- This specification depends on the LCD panel characteristics. Please refer to the manufacturer’s panel specification for details.

Item	Symbol	Min	Max	Unit
Operating Temperature	TOP	0	+50	°C
Operating Humidity	HOP	10	90	%
Storage Temperature	TST	-20	+60	°C
Storage Humidity	HST	10	90	%

### 1.4 Power Supply Rating

Optional PSU Input Voltage	AC 100 ~ 240VAC,50/60Hz			
Optional PSU Output Voltage	DC 24V / 6.6A			
Monitor DC Input Voltage	24VDC			
Power Consumption	TBD			
LED String Lighting Specification (12V Addressable, w/IC type)	Min	Typ.	Max	Unit
Input Voltage	11.4	12.0	12.6	[V]
Input Current		TBD		[A]
Power Consumption		TBD		[W]

- Conditions of Measurement
  - 1) LED pattern: LED Bar full white light, non-scrolling.
  - 2) Current consumption tolerance: + 10%.

### 1.5 Input/Output Port

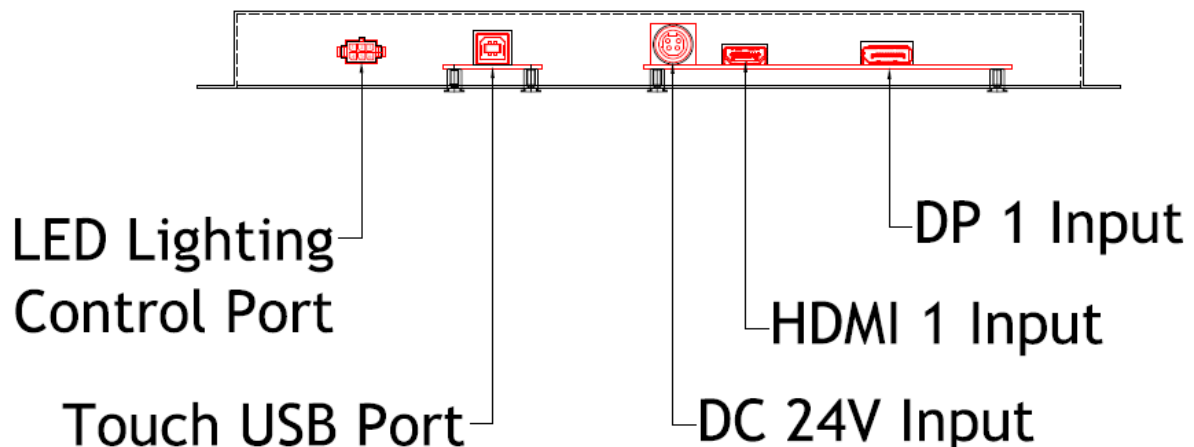

## 2. User Control & OSD

### 2.1 Key Control Board

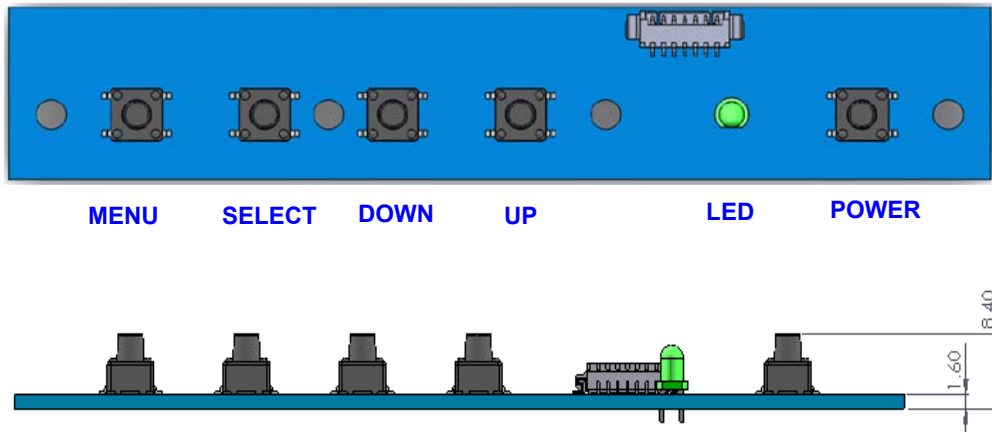
**K002**

Button	Function	Status	HOT Key
LED	Indicates operation status	Green : Normal State Red : Off Mode Green Blinking : DPMS Mode	
POWER	Power on/off		
MENU	Enable MENU Window Disable MENU Window Exit from Sub function		
SELECT	Select function		No OSD Window, Input Source Change
DOWN	Move to Down or Left		No OSD Window, Auto Color
UP	Move to Up or Right		No OSD Window, Auto Configuration

## 2.2 OSD Control Function

The chosen OSD settings will be stored in memory. The OSD menu can be cleared from the screen by pressing the **MENU** button otherwise it will be automatically cleared after a few second of non-use.

### 2.2.1 OSD Main Menu

#### 1) PICTURE

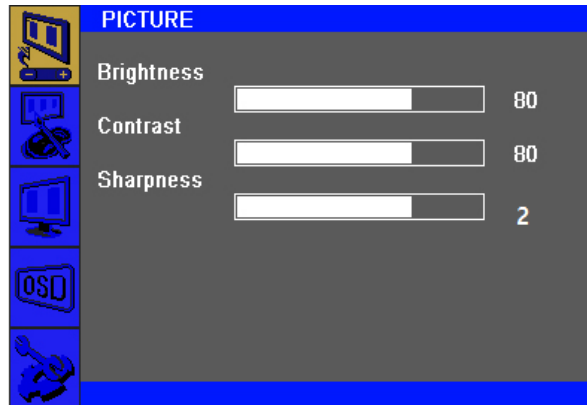

Brightness (0 ~ 100)	Increases/decreases monitor Brightness. Default: 100
Contrast (0 ~ 100)	Increases/decreases monitor Contrast. Default: 100
Sharpness (0 ~ 4)	Adjusts Sharpness of the displayed images. Default : 2

#### 2) COLOR

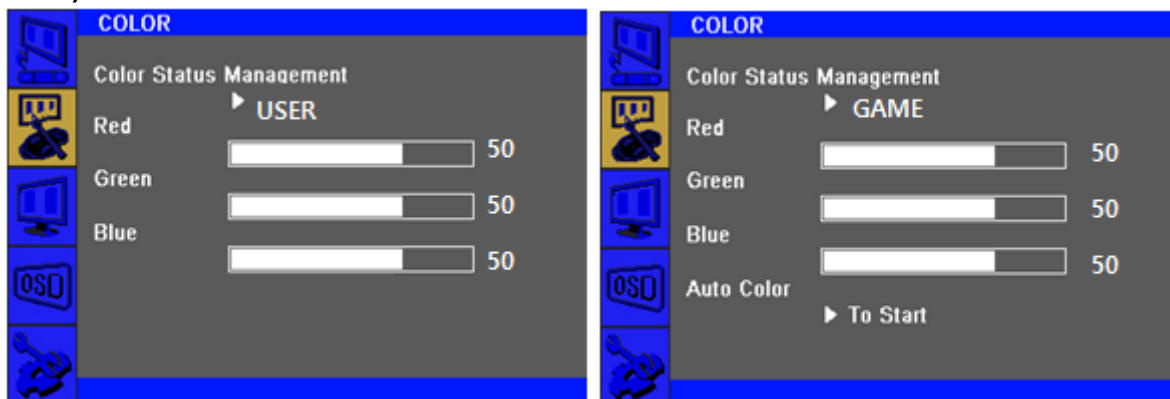

Color Status Management	Selects the display's color temperature. The available color settings "Normal", "Warm", "Cool", "User" and "Game" mode. Default : User
Red (0 ~ 100)	Increases/decreases Red Color Temperature. Default : 50
Green (0 ~ 100)	Increases/decreases Green Color Temperature. Default : 50
Blue (0 ~ 100)	Increases/decreases Blue Color Temperature. Default : 50

### 3) OSD

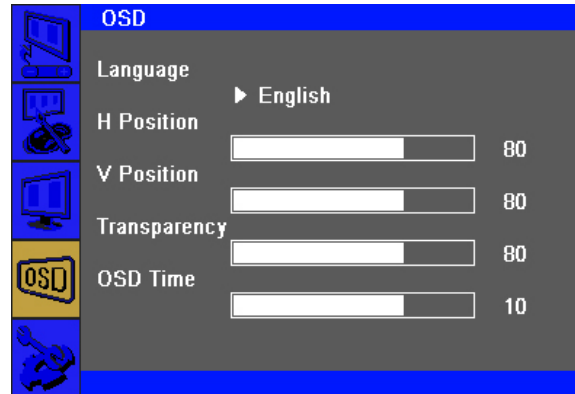

Language	Selects the OSD's display language. The available languages are English, Deutsch, Français, Italiano, Español, Korean. Default : English
H Position (0 ~ 100)	Adjusts the horizontal location of the OSD menus on the display. Default : 50
V Position (0 ~ 100)	Adjusts the vertical location of the OSD menus on the display. Default : 50
Transparency (0 ~ 100)	Adjusts the transparency of the OSD menus on the display. Default : 33
OSD Time (0 ~ 60)	Adjusts how long the touch monitor will wait without OSD button activity before closing the OSD. The adjustable range is between 0 and 60 seconds. Default : 10

### 4) SETUP

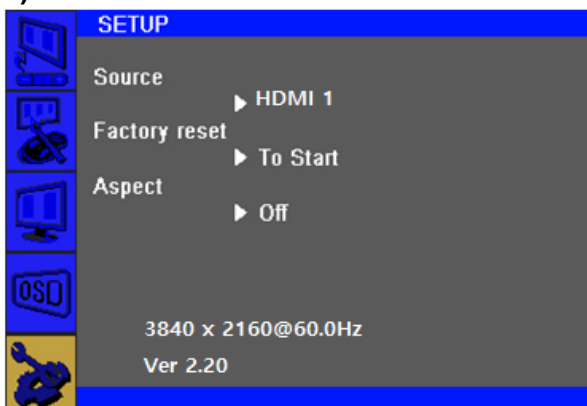

### 5) Input Source

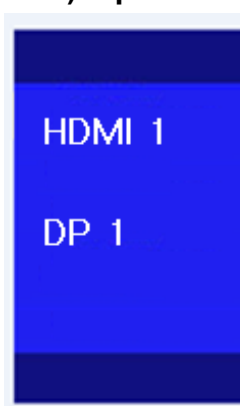

Source	Selects Input Source HDMI1, DP1,
Factory reset	Restores all factory default settings for OSD-adjustable parameters and for Preset Video Mode timings.
Aspect	Switches the scaling method between Full Scaling and Maintain Aspect Ratio. Default : Off

### 3. Connector Description

#### 3.1 Overview

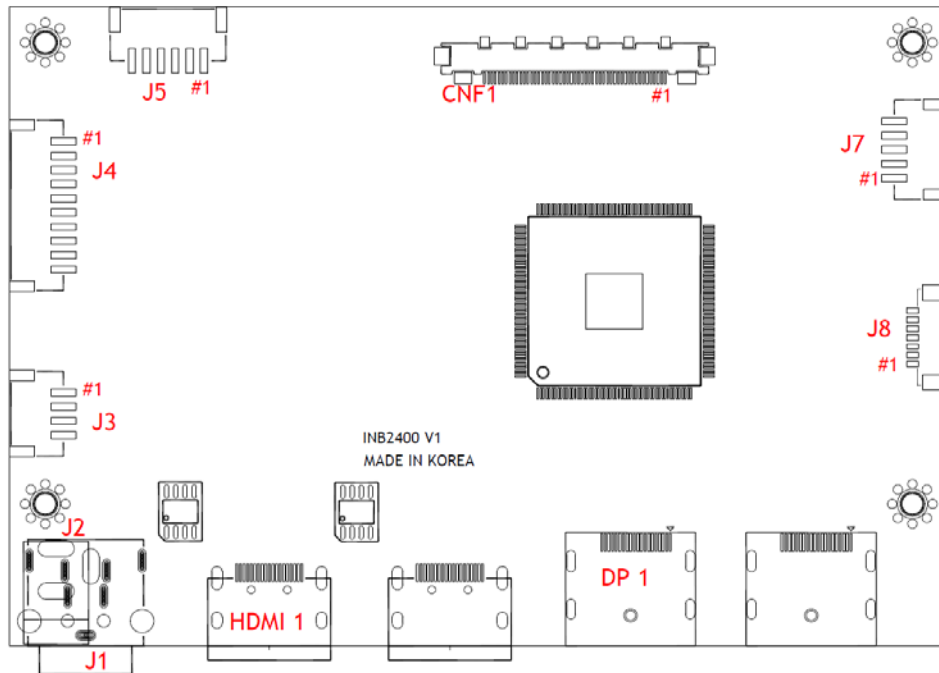

Reference	Item	Description	Type	Manufacture
J1	Jack	24V Input DC Power Jack	KPJ-4S	-
J2	Jack	12V Input DC Power Jack (Optional)	DC-005	
J3	Connector	SMPS Input Power Connector	20022WR-04	YEONHO
J4	Connector	Backlight Inverter Connector	20022WR-10	YEONHO
J5	Connector	5V/12V DC Power Output Connector	20022WR-06	YEONHO
CNF1	Connector	V By One Output (8Lane)	FI-RE51S-HF	JAE
J6	Connector	eDP Output (4Lane / 8Lane / HBR2) Position : PCB Bottom	20453-040T	IPEX
J7	Connector	Auto-Dimming/RS232 Connector	20022WR-05	YEONHO
J8	Connector	OSD Board Connector	12505WR-07	YEONHO
HDMI1	Connector	HDMI Input(TMDS) Connector	HDMI 19P	-
DP1	Connector	DP Input(TMDS) Connector	DP 20P	-

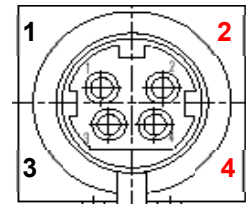

**3.2 J1 :24VDC Power Input Jack (Optional)**

Pin No.	Symbol	Description
1,3	GND	Ground
2,4	VCC	VDC12V or VDC24V

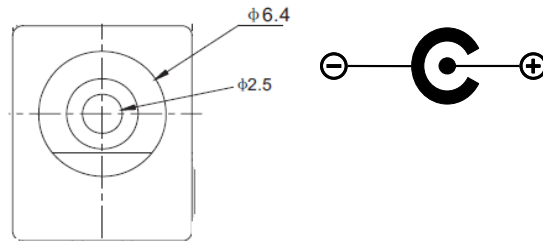

**3.3 J2: 12VDC Power Input Jack (Optional)**

Pin No.	Symbol	Description
-	GND	Ground
+	VCC	12VDC

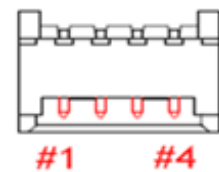

**3.4 J3: SMPS Input Power Input Connector: 20022WR-04 (Yeonho or EQ)**

Pin No.	Symbol	Description
1	VCC	12VDC
2	VCC	12VDC
3	GND	Ground
4	GND	Ground

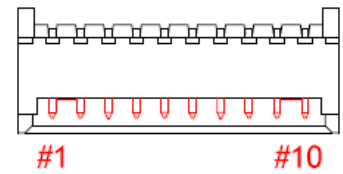
**3.5 J4: Backlight Inverter Connector: 20022WR-10 (Yeonho or EQ)**

Pin No.	Symbol	Description
10	DIM-ADJ	DIM-adjustment Analog dimming or PWM control signal. * make sure inverter specification (Firmware Optional)
9	ON/OFF	Backlight digital ON (5.0V) / OFF (0V) signal.
5,6,7,8	GND	Ground
1,2,3,4	VCC	12VDC or 24VDC

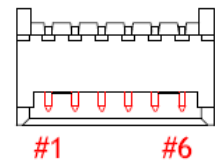

**3.6 J5: DC Power Output Connector: 20022WR-06 (Yeonho or EQ)**

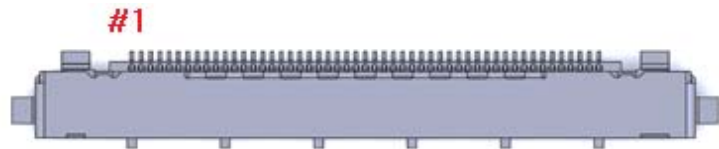
Pin No.	Symbol	Description
1,2	VCC	+12V
3,4	VCC	+5V
5,6	GND	Ground

**3.7 CNF1: V by One (8Lane) Output Connector: FI-RE51S-HF (JAE or EQ)**

Pin No.	Symbol	Description
1	GND	Ground
2	VTX_TX7N	VTX_TX7N
3	VTX_TX7P	VTX_TX7P
4	GND	Ground
5	VTX_TX6N	VTX_TX6N
6	VTX_TX6P	VTX_TX6P
7	GND	Ground
8	VTX_TX5N	VTX_TX5N
9	VTX_TX5P	VTX_TX5P
10	GND	Ground

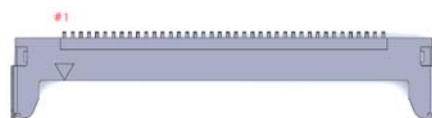
11	VTX_TX4N	VTX_TX4P
12	VTX_TX4P	VTX_TX4N
13	GND	Ground
14	VTX_TX3N	VTX_TX3P
15	VTX_TX3P	VTX_TX3N
16	GND	Ground
17	VTX_TX2N	VTX_TX2P
18	VTX_TX2P	VTX_TX2N
19	GND	Ground
20	VTX_TX1N	VTX_TX1P
21	VTX_TX1P	VTX_TX1N
22	GND	Ground
23	VTX_TX0N	VTX_TX0P
24	VTX_TX0P	VTX_TX0N
25	GND	Ground
26	VTX_PLL_Lock	VTX_PLL_Lock
27	VTX_HPDP	V-by-One Hot Plug Detect
28	GND	Ground
29	V-by-one Bit Select	V-by-One 8bit/10bit Select
30	NC	LED Enable(Optional)
31	GND	No Connection
32	NC	No Connection
33	NC	No Connection
34	NC	No Connection
35	AUX_CH_N2	AUX_CH_N2
36	AUX_CH_P2	AUX_CH_P2
37	GND	Ground
38	AUX_CH_N1	AUX_CH_N1
39	AUX_CH_P1	AUX_CH_P1
40, 41, 42	GND	Ground
43	NC	No Connection
44, 45, 46, 47, 48, 49, 50, 51	PANEL_VDD	10V/12VDC Output for Panel



**3.8 J6: eDP (4/8Lane) Output Connector: 20453-040T (IPEX or EQ) /  
Position : PCB Bottom Side**

Pin No.	Symbol	Description
1, 2, 3	PANE_VDD	10V/12VDC Output for Panel
5, 6, 7	GND	Ground
4, 8, 9, 10	NC	No Connection
11	eDP1_HPD	TX HPD1
12	2 <sup>nd</sup> _AUXN	2 <sup>nd</sup> TX_AUX_N
13	2 <sup>nd</sup> _AUXP	2 <sup>nd</sup> TX_AUX_P
14	GND	Ground
15	DPTX_L7N	DPTX_L7N
16	DPTX_L7P	DPTX_L7P
17	GND	Ground
18	DPTX_L6N	DPTX_L6N
19	DPTX_L6P	DPTX_L6P
20	GND	Ground
21	DPTX_L5N	DPTX_L5N
22	DPTX_L5P	DPTX_L5P
23	GND	Ground
24	DPTX_L4N	DPTX_L4N
25	DPTX_L4P	DPTX_L4P
26	eDP0_HPD	TX HPD0
27	1 <sup>st</sup> _AUXN	1 <sup>st</sup> TX_AUX_N
28	1 <sup>st</sup> _AUXP	1 <sup>st</sup> TX_AUX_P
29	GND	Ground
30	DPTX_L3N	DPTX_L3N
31	DPTX_L3P	DPTX_L3P
32	GND	Ground
33	DPTX_L2N	DPTX_L2N
34	DPTX_L2P	DPTX_L2P
35	GND	Ground
36	DPTX_L1N	DPTX_L1N
37	DPTX_L1P	DPTX_L1P
38	GND	Ground
39	DPTX_L0N	DPTX_L0N
40	DPTX_L0P	DPTX_L0P

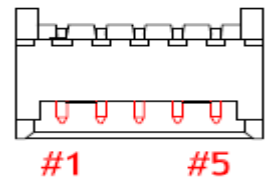

**3.9 J7: Auto-Dimming / RS232 Connector: 20022WR-05 (Yeonho or EQ)**

Pin No.	Symbol	Description
1	5VDC	VCC 5V
2	RS232 TX	RS232 TX
3	RS232 RX	RS232 RX
4	Auto- Backlight	Auto-Dimming
5	GND	Ground

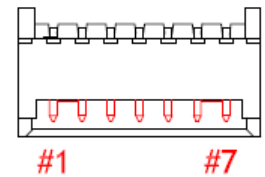

**3.10 J8: OSD Board Connector: 12505WR-07 (Yeonho or EQ)**

Pin No.	Symbol	Description
1	VCC	+5V Power for IR sensor
2	IRQ	Infrared rays signal line.
3	LED1	Green LED
4	LED2	Red LED
5	GND	Ground
6	ADC-IN0	Menu, Up
7	ADC-IN1	Power, Down, Up

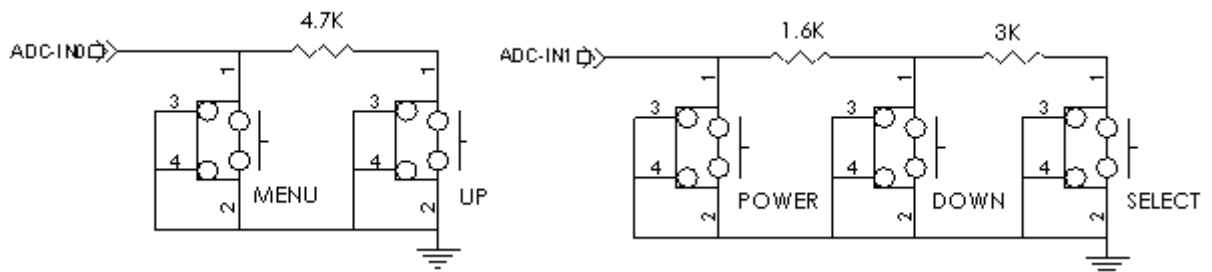

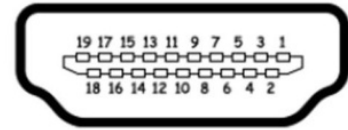

3.11 HDMI 1: HDMI Input (TMDS) Connector

Pin No.	Symbol	Description
1	TMDS DATA2-	TMDS DATA2 Differential Negative Signal
2	TMDS DATA2+	TMDS DATA2 Differential Positive Signal
3	TMDS DATA2 Shield	Shield for TMDS Channel #2
4	TMDS DATA1-	TMDS DATA1 Differential Negative Signal
5	TMDS DATA1+	TMDS DATA1 Differential Positive Signal
6	TMDS DATA1 Shield	Shield for TMDS Channel #1
7	TMDS DATA0-	TMDS DATA0 Differential Negative Signal
8	TMDS DATA0+	TMDS DATA0 Differential Positive Signal
9	TMDS DATA0 Shield	Shield for TMDS Channel #0
10	TMDS CLOCK Shield	Shield for TMDS Clock differential Pair
11	TMDS CLOCK+	TMDS DATA0 Differential Positive Signal
12	TMDS CLOCK-	TMDS DATA0 Differential Negative Signal
13	CEC	CEC Function
14	NC	No Connection
15	DDC Clock	DDC Clock Signal
16	DDC data	DDC Data Signal
17	GND	Ground
18	+5V Power	+5V Power
19	HPD	Identify the presence of a monitor

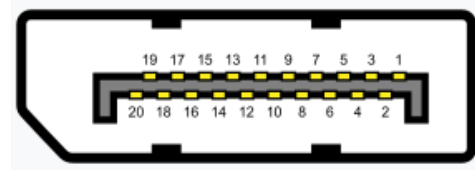
**3.12 DP1: DP Input Connector**

Pin No.	Symbol	Description
1	LANE3-	Component Signal for Main Link 3
3	LANE3+	True Signal for Main Link 3
4	LANE2-	Component Signal for Main Link 2
6	LANE2+	True Signal for Main Link 2
7	LANE1-	Component Signal for Main Link 1
9	LANE1+	True Signal for Main Link 1
10	LANE0-	Component Signal for Main Link 0
12	LANE0+	True Signal for Main Link 0
13	CA DET	No Connection
14	DP DET+	No Connection
15	AUX CH+	True Signal for Auxiliary Channel
16	GND	Ground
17	AUX CH-	Component Signal for Auxiliary Channel
18	+5V Power	Identify the presence of a monitor
19	RETURN	No Connection
20	PWR OUT	No Connection

## 4. Standard Display Modes

Spec Mode	Pixel Freq.	Horizontal Timing				Vertical Timing			
		Sync Polar	Freq.	Total	Active	SP	Freq.	Total	Active
	MHz		KHz	Pixel	Pixel		Hz	Line	Line
640*480@60Hz	28.175	N	31.469	800	640	N	59.940	525	480
640*480@72Hz	31.500	N	37.861	832	640	N	72.809	520	480
640*480@75Hz	31.500	N	37.500	840	640	N	75.000	500	480
800*600@60Hz	40.000	P	37.879	1056	800	P	60.317	628	600
800*600@72Hz	50.000	P	48.077	1040	800	P	72.188	666	600
800*600@75Hz	49.500	P	46.875	1056	800	P	75.000	625	600
1024*768@60Hz	65.000	N	48.363	1344	1024	N	60.005	806	768
1024*768@70Hz	75.000	N	56.476	1328	1024	P	70.070	806	768
1024*768@75Hz	78.750	P	60.023	1312	1024	P	75.030	800	768
1280*720@60Hz	74.500	P	44.772	1664	1280	P	59.855	748	720
1360*768@60Hz	84.75	P	47.72	1776	1360	P	59.799	798	768
1280*1024@60Hz	108.000	P	63.981	1688	1280	P	60.020	1066	1024
1280*1024@75Hz	135.000	P	79.976	1688	1280	P	75.035	1066	1024
1600*900@60Hz	97.750	N	55.540	1760	1600	N	59.978	926	900
1680*1050@60Hz	119.125	P	64.742	1840	1680	N	59.946	1080	1050
1600*1200@60Hz	162,000	P	75,000	2160	1600	P	60.00	1250	1200
1920*1080@60Hz	138.625	P	66.647	2080	1920	N	59.988	1111	1080
1920*1200@60Hz	154.125	P	74.099	2080	1920	N	59.999	1235	1200
2560*1600@60Hz	268.500	P	98.713	2720	2560	N	60.010	1641	1600
3840*2160@30Hz	585.980		129.600	4480	3840		30.000	2180	2160
3840*2160@60Hz	585.980		129.600	4480	3840		60.000	2180	2160

## 5. LED Backlight Driver Board Specification

### 5.1 Electrical Specification

Parameter		Min.	Typ.	Max.	Unit	Remarks
LED Forward Voltage	$V_F$	58.8	63	67.2	V	-
LED Forward Current	$I_F$	-	960	-	mA	-
LED Driver Power Consumption	$P_{LED}$	-	71.15	-	W	Note 1
LED Life-Time	N/A	30000	-	-	Hour	$I_F = 480mA$
PWM Control Level	PWM High Level	-	-	-	V	
	PWM Low Level	-	-	-	V	
PWM Control Frequency	$F_{PWM}$	-	-	-	Hz	
Duty Ratio	-	-	-	-	%	

### 5.2 Interface

#### 5.2.1 CN1 Connector: 20010WR-14 (YeonHo) or EQ

Pin	Symbol	Remarks
1,2,3,4,5	$V_{in}$	Input Voltage 24VDC
6,7,8,9,10	GND	GND
12	On/Off	Backlight On/Off (5V:On, 0V : Off)
13	PDIM	Diming Control 0V:Max, 5V:Min
11, 14	NC	

## 6. Board Dimensions

### 6.1 AD Board (INB2400A V1) Dimension (130mm x 90mm x 14.3mm)

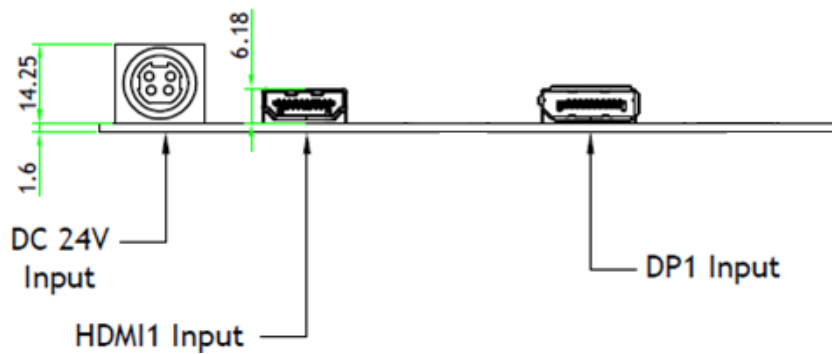
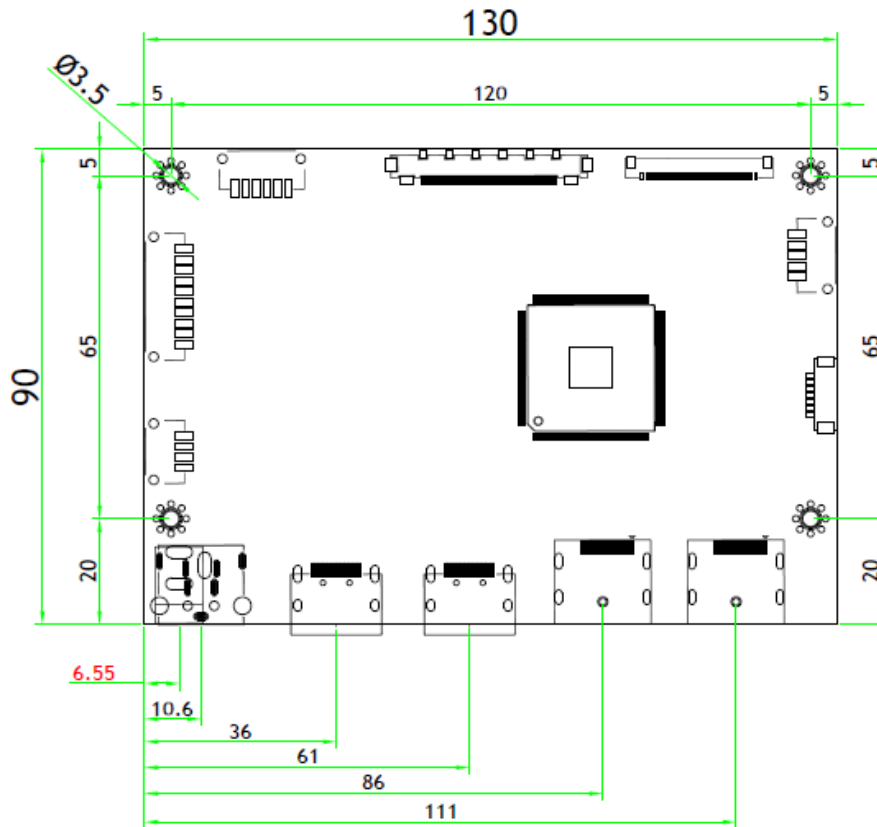

### 6.2 OSD Board (K002) Dimension (115mm x 20mm x 8.7mm)

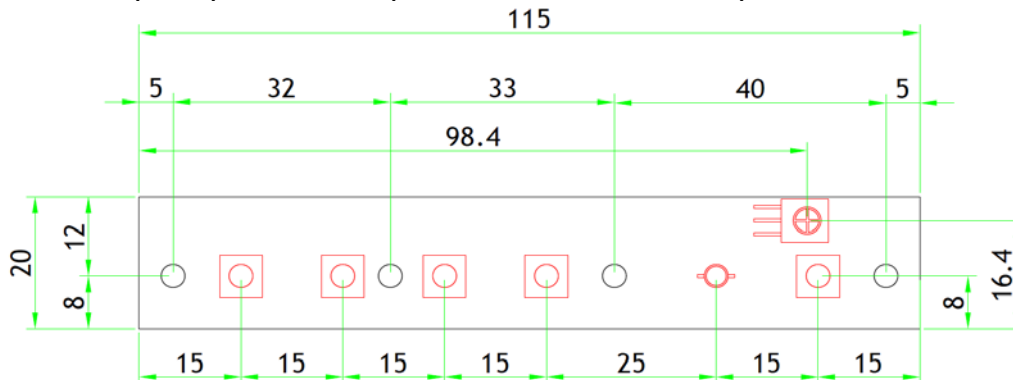

## 7. LED Lighting Control Interface Specification

### 7.1 Connector Spec

- Connector: Molex 43020-0600



- Matching Housing: Molex 43025-0600



### 7.2 External LED Connector Pin Map

#### 7.2.1 With IC (Dual-Line) LED Bar Board

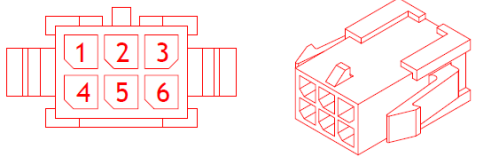
Pin No	Description	Connector (Molex 43020-0600)
P1	12V	
P2	CTL (Contol Line)	
P3	GND	
P4	NC	
P5	NC	
P6	NC	

Pin No	Symbol	Remark
1	12V	DC 12V (Master)
2	CTL	With IC LED Control Line
3	GND	GND
4	NC	Non Connection
5	NC	Non Connection
6	NC	Non Connection

### 7.3 LED (WS2815B) Spec

#### 7.3.1 LED (WS2815B) Pin Configuration

##### PIN Configuration



##### PIN Function

NO.	Symbol	PIN	Function description
1	VCC	VCC	IC POWER SUPPLY, Suspended or connected with a filter capacitor to GROUND
2	VDD	VDD	LED POWER SUPPLY, connect to "+12V"
3	DO	DO	Control data signal output
4	DIN	DIN	Control data signal input
5	GND	GND	Data & Power Grounding
6	BIN	BIN	Backup Control data signal input

#### 7.3., LED (WS2815B) Circuit

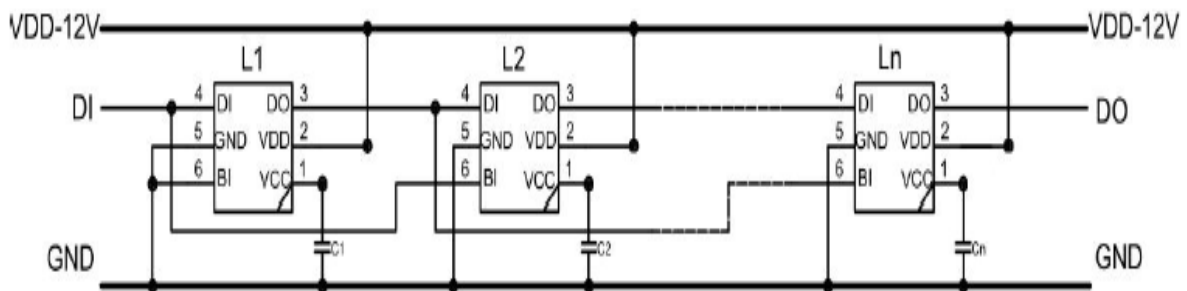

## 8. P-CAP Touchscreen Specification

### 8.1 Touch Controller Specifications

- TBD

### 8.2 Touch Control Board Dimension (125.0mm x 45.0mm)



### 8.4 USB Connector (USB 2.0, Type “B”)

Number	Signal Name
1	+5V
2	D-
3	D+
4	GND

### 8.4. Touch Screen Dimension (1020.0mm x 610.0mm x 4.35mm)

### 8.5. USB Interface Port

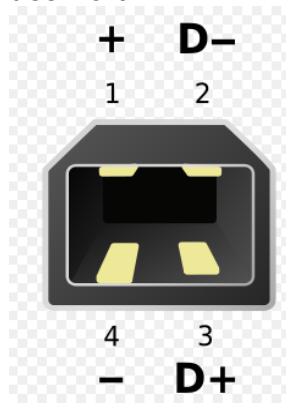

## 9. Packing Information

Item	Q'ty	Dimension (W x H x D)	Weight(Kg)	Remark
Closed Frame	1Pcs	1020.0mm x 610.0mm x 61.8mm	TBD	
Box Packing			TBD	
Pallet Size			TBD	
Pallet Packing			TBD	

## 10. Mechanical structure

ASSEMBLY ITEM NUMBER	PART CHARACTERISTICS		MATERIAL
	NUMBER OF POSITION	PANEL MOUNT OPTION	
	43020-0200	02	
43020-0201	02	NO	
43020-0400	04	YES	
43020-0401	04	NO	
43020-0600	06	YES	
43020-0601	06	NO	
43020-0800	08	YES	
43020-0801	08	NO	
43020-1000	10	YES	
43020-1001	10	NO	
43020-1200	12	YES	
43020-1201	12	NO	
43020-1400	14	YES	
43020-1401	14	NO	
43020-1600	16	YES	
43020-1601	16	NO	
43020-1800	18	YES	
43020-1801	18	NO	
43020-2000	20	YES	
43020-2001	20	NO	
43020-2200	22	YES	
43020-2201	22	NO	
43020-2400	24	YES	
43020-2401	24	NO	

CKT. NO.	DIM. 'A'	DIM. 'B'	DIM. 'C'	DIM. 'D'
2	.152/(3.86)	N/A	.166/(4.21)	.311/(7.90)
4	.270/(6.85)	.118/(3.00)	.284/(7.21)	.429/(10.90)
6	.388/(9.85)	.236/(6.00)	.402/(10.21)	.547/(13.89)
8	.506/(12.85)	.354/(9.00)	.520/(13.21)	.665/(16.89)
10	.624/(15.85)	.472/(12.00)	.638/(16.21)	.783/(19.89)
12	.742/(18.85)	.591/(15.00)	.756/(19.21)	.901/(22.89)
14	.860/(21.85)	.709/(18.00)	.874/(22.20)	1.019/(25.88)
16	.978/(24.85)	.827/(21.00)	.992/(25.20)	1.137/(28.88)
18	1.096/(27.85)	.945/(24.00)	1.110/(28.20)	1.255/(31.88)
20	1.215/(30.85)	1.063/(27.00)	1.229/(31.22)	1.373/(34.87)
22	1.333/(33.85)	1.181/(30.00)	1.347/(34.22)	1.491/(37.87)
24	1.451/(36.85)	1.299/(33.00)	1.465/(37.22)	1.609/(40.87)

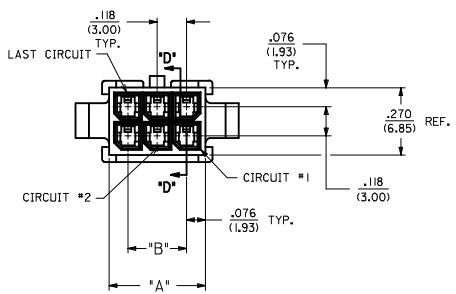

- NOTES:
- HOUSING MATERIAL:
  - 'A' - UNFILLED POLYESTER, RATED U.L. 94V-0, COLOR IS BLACK.
  - 'B' - UNFILLED NYLON, RATED U.L. 94V-0, HALOGEN-FREE, COLOR IS BLACK.
  - FINISH: N/A
  - PRODUCT SPECIFICATION: PS-43045
  - PACKAGING SPECIFICATION: PK-43020-001
  - THIS HOUSING MATES WITH MICRO-FIT RECEPTACLE #43025-\*\*\*\*
  - THIS HOUSING TO BE USED WITH MOLEX MALE TERMINAL #43031-\*\*\*\*
  - DESIGNED FOR .055(1.4) MINIMUM TO A .100(2.54) MAXIMUM THICK PANEL OR PRINTED CIRCUIT BOARD.
  - SEE SECTION 'D'-D' FOR TERMINAL ORIENTATION IN HOUSING.
  - PANEL MOUNT FEATURES MUST LOCK ON SIDE OPPOSITE PUNCH SIDE FOR OPTIMUM RETENTION.
  - PART CONFORMS TO CLASS 'B' REQUIREMENTS OF COSMETIC SPECIFICATION PS-45499-002. SOME HOUSINGS MAY HAVE A SMALL GATE BLEMISH NEAR THE GATE LOCATION THAT DOES NOT AFFECT FUNCTIONALITY.

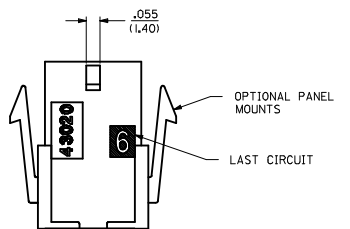
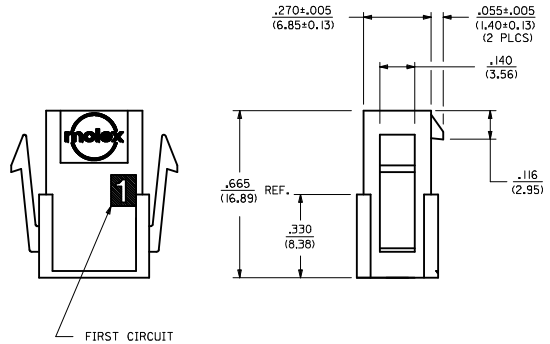
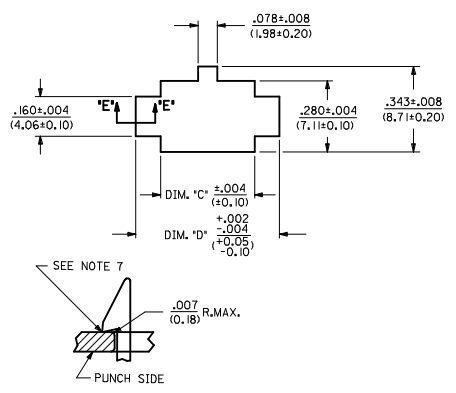

SEE NOTE 7

RECOMMENDED PANEL CUT-OUT (SEE NOTES 7 & 9)

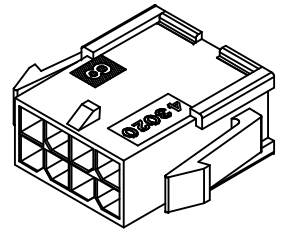
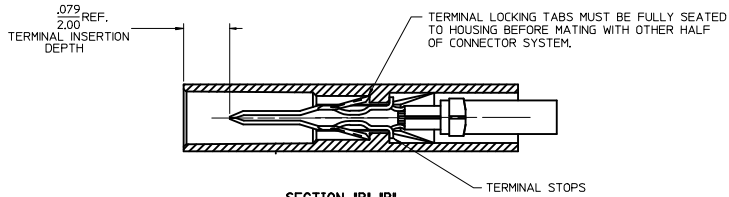

PLUG WITH OPTIONAL PANEL MOUNTS  
ISO VIEW  
(8 CIRCUIT SHOWN)

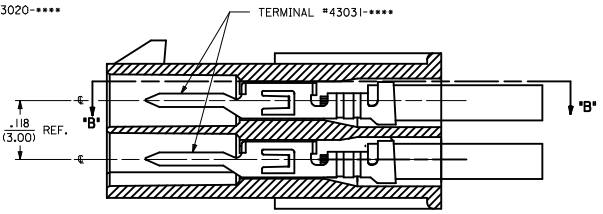
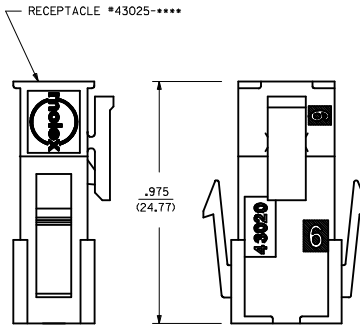

MATED MICRO-FIT CONNECTOR

SECTION 'D'-D' WITH TERMINAL SCALE 8X

UPDATE PUNCHED HOLE IEC NO. UCF2017-0525 DRAWN/OUTLES 2016/09/13 CHKD/SSOUSEK 2016/09/13 APPR/FSM TH 2016/10/07	QUALITY SYMBOLS	GENERAL TOLERANCES (UNLESS SPECIFIED)	DIMENSION STYLE	SCALE	DESIGN UNITS	THIRD ANGLE PROJECTION
	▽=0	mm INCH	IN/MM	METRIC		
	▽=0	4 PLACES ±.010	DRAWN BY DATE	1993/01/07	TITLE	
	▽=0	3 PLACES ±.014	CHECKED BY DATE	1993/01/07	MICRO-FIT(3,0) 2 THRU 24 CIRCUIT PLUG WITH OPTIONAL PANEL MOUNTS	
	ANGULAR ±1/2°	DRAFT WHERE APPLICABLE MUST REMAIN WITHIN DIMENSIONS	MATERIAL NO.	DOCUMENT NO.	SHEET NO.	
			SEE CHART	SDA-43020-****	1 OF 1	
			THIS DRAWING CONTAINS INFORMATION THAT IS PROPRIETARY TO MOLEX INCORPORATED AND SHOULD NOT BE USED WITHOUT WRITTEN PERMISSION			

PART CHARACTERISTICS		
NUMBER OF POSITION	ASSEMBLY ITEM NUMBER	MATERIAL
02	43025-0200	'B'
04	43025-0400	
06	43025-0600	
08	43025-0800	
10	43025-1000	'A'
12	43025-1200	
14	43025-1400	'B'
16	43025-1600	'A'
18	43025-1800	'B'
20	43025-2000	
22	43025-2200	'A'
24	43025-2400	

CKT. NO.	DIM. "A" +0.14 -0.10 +0.35 -0.25	DIM. "B"
2	.152/(3.86)	N/A
4	.270/(6.85)	.118/(3.00)
6	.388/(9.85)	.236/(6.00)
8	.506/(12.85)	.354/(9.00)
10	.624/(15.85)	.472/(12.00)
12	.742/(18.85)	.591/(15.00)
14	.860/(21.85)	.709/(18.00)
16	.978/(24.85)	.827/(21.00)
18	1.096/(27.85)	.945/(24.00)
20	1.215/(30.85)	1.063/(27.00)
22	1.333/(33.85)	1.181/(30.00)
24	1.451/(36.85)	1.299/(33.00)

- NOTES:**
- HOUSING MATERIAL:  
'A' - UNFILLED POLYESTER, RATED UL, 94V-0, COLOR IS BLACK.  
'B' - UNFILLED NYLON, RATED UL, 94V-0, HALOGEN-FREE, COLOR IS BLACK.
  - FINISH: N/A
  - PRODUCT SPECIFICATION: PS-43045
  - PACKAGING SPECIFICATION: PK-43025-001
  - THIS RECEPTACLE MATES WITH 43020, 43045.
  - THIS RECEPTACLE TO BE USED WITH MOLEX FEMALE TERMINAL SERIES 43030 OR 46235. SEE SECTION 'A'-A' FOR TERMINAL ORIENTATION IN HOUSING.
  - FOR OVERMOLDING PARAMETERS SEE ENGINEERING SPECIFICATION #SDS-43025-1000.
  - TOP PULL TABS ARE NOT AVAILABLE ON 2 AND 4 CIRCUIT PARTS.
  - MOLEX RECOMMENDS THE USE OF MICRO-FIT TEST PLUG, SERIES NO. 44242-\*\*\*\*\* WHENEVER TESTING IS PERFORMED. TEST PLUGS MUST NOT BE USED FOR MAKE OR BREAK UNDER LOAD. MOLEX DOES NOT RECOMMEND USING STANDARD MATING COMPONENTS FOR HARNESS TESTING PURPOSES.
  - SOME HOUSINGS MAY HAVE A SMALL GATE BLEMISH NEAR THE GATE THAT DOES NOT AFFECT FUNCTIONALITY.
  - HOUSINGS HAVE EITHER AN IDENTIFIER RIB OR ENGRAVED '1' SYMBOL TO INDICATE CIRCUIT #1. IDENTIFIER TYPE IS TOOL DEPENDENT AND NOT SELECTABLE.
  - DIMENSION 'A' MEASURED AT DATUM  $\square$ -A-
  - THIS PART CONFORMS TO CLASS 'B' REQUIREMENTS OF COSMETIC SPECIFICATION PS-45499-002.

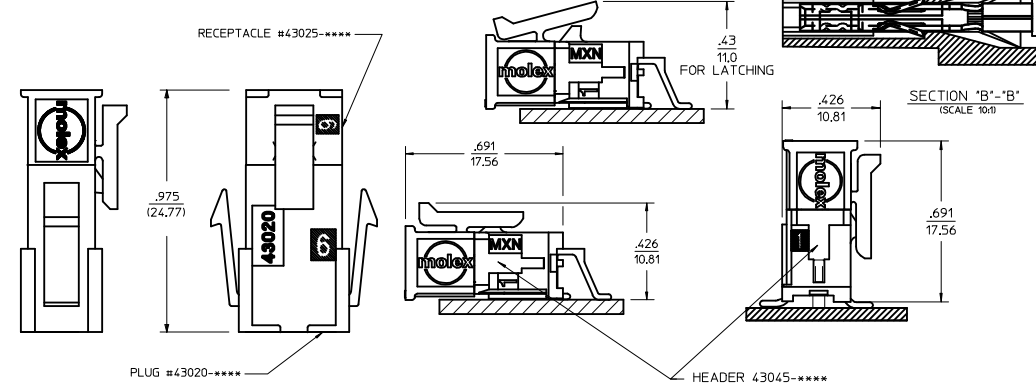
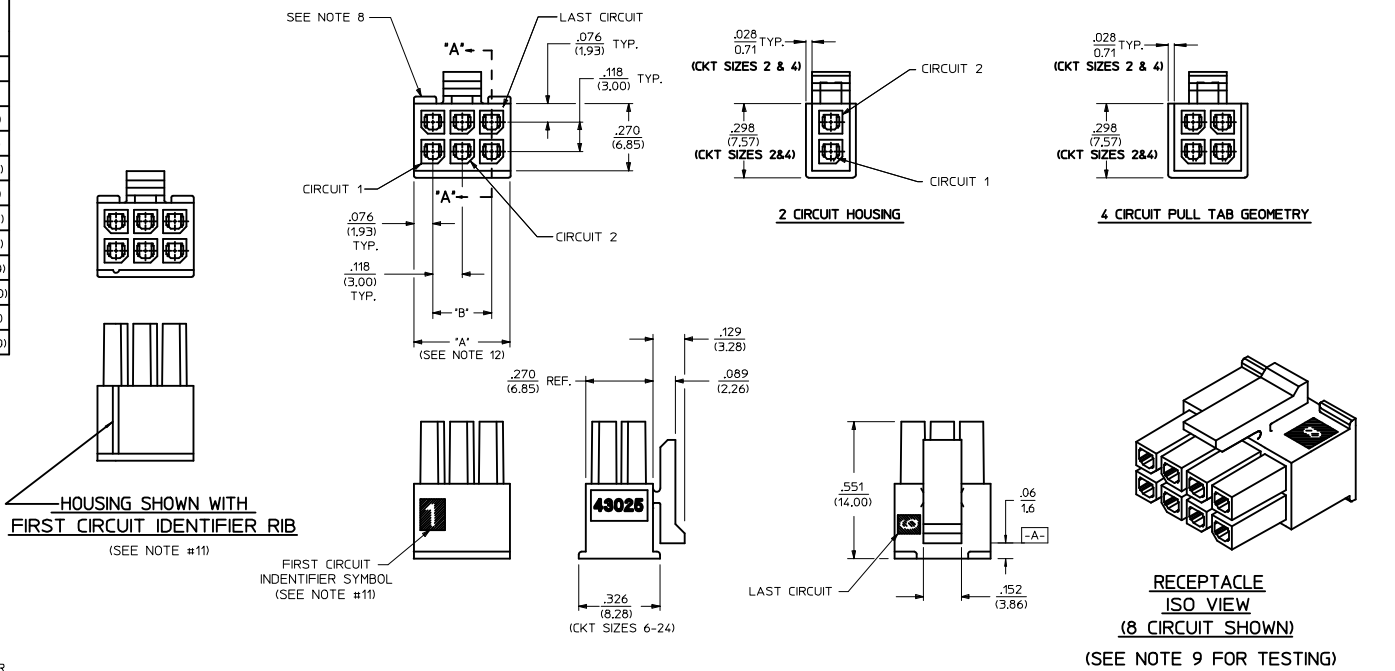

ADD MATED VIEW LEC NO: UCP2016-4677 DRAWN BY: DRYNAPPELDORN CHKD: JDOX APPROVED: JSMITH	QUALITY SYMBOLS ▽=0 ▽=0 ▽=0	GENERAL TOLERANCES (UNLESS SPECIFIED)		DIMENSION STYLE		SCALE	DESIGN UNITS	THIRD ANGLE PROJECTION
		mm	INCH	IN/MM				
04	4 PLACES	±.010	±.010	A. F. G.	DATE	1993/01/14	METRIC	MICRO-FIT (3.0) 2 THRU 24 CIRCUIT RECEPTACLE
	3 PLACES	±.010	±.010	CHECKED BY	DATE			
	2 PLACES	±.025	±.014	B. A. P.	DATE			
	1 PLACE	±.035	±.010	APPROVED BY	DATE			
	0 PLACE	±.050	±.010	FSMITH	2016/05/02			
ANGULAR ±1/2°		DRAFT WHERE APPLICABLE MUST REMAIN WITHIN DIMENSIONS		MATERIAL NO. <b>SEE CHART</b>		DOCUMENT NO. SDA-43025-****	SHEET NO. 1 OF 1	
THIS DRAWING CONTAINS INFORMATION THAT IS PROPRIETARY TO MOLEX INCORPORATED AND SHOULD NOT BE USED WITHOUT WRITTEN PERMISSION								